

NAUTILUS

PORTABLE EXTRACTOR



Nautilus MX3-1200 Operating Manual

HF HYDRO-FORCE™
Innovating since 1974

TABLE OF CONTENTS

<u><i>TOPIC</i></u>	<u><i>PAGE #</i></u>
• Introduction	3
• Technical Specifications	4
• Optional Equipment	5
 <u>SECTION 1: Operational Safety</u>	
• Electrical Safety	6
• Mechanical Safety	7
 <u>SECTION 2: Operation Procedures</u>	
• Vacuum Connections	8
• Electrical Supply	9
• Water Supply & Chemicals	10
• Solution Hose & Pump Priming	13
• Vacuum Hoses	14
• Pump-Out System	15
• Pressure Adjustments	16
• Shutdown Procedures	17
• Accessory Storage	18
• Troubleshooting	19
• Solution Flow Path	20
• Wiring Diagrams	23
 <u>SECTION 3: Maintenance/ Technical</u>	
• Maintenance	26
• Drawings & Parts Lists	
○ Pump	35
○ Auto-Fill	37
○ Pressure Unloader	39
○ Pump-Out Pump	40
○ Parts Pictures	41
○ Parts List	52
○ Hose List	55
• Warranty	56

Introduction

Congratulations on your purchase of the Hydro-Force Nautilus MX3-1200. The MX3-1200 is designed to give truckmount-level performance in a portable machine that combines versatility with ease of transport. Years of experience, engineering, and planning have gone into the design and manufacturing of the MX3-1200. We take a great deal of pride in the MX3-1200; our goal is no less than your complete satisfaction.

The Hydro-Force Nautilus MX3-1200 is intended for commercial use only.

This manual will provide users with the knowledge required to operate the Nautilus MX3-1200 safely, to understand how to properly operate and maintain the machine, and to ensure that the equipment operates at its maximum performance level.



All users must read and understand this manual completely before operating the machine.

Always maintain this manual in legible condition adjacent to the Nautilus MX3-1200, or place in a secure location for future reference.

Any questions pertaining to the operating or servicing of this unit should be directed to your nearest Hydro-Force distributor.

This manual is written specifically for the Nautilus MX3-1200 portable extractor units manufactured by:

AramSCO
4282 South 590 West
Salt Lake City, UT 84123
801-268-2673
801-268-3856 FAX

Information in this manual is subject to change without notice and does not represent a commitment on the part of Hydro-Force or its parent or affiliated companies.

Technical Specifications

MX3-1200 High Pressure Extractor

Height: 42-1/4"

Length: 34-3/8"

Width: 23-3/8"

Weight: 160 lbs.

Solution Tank Capacity: 12 gallon

Recovery Tank Capacity: 12 gallon

Solution Pump: Pump-Tec #356 pump with 1-1/2 HP Motor
0-1200 psi – 2.2 gpm

Vacuum Motors: Two AMETEK Lamb 5.7" diameter 3-Stage – tangential discharge
Can be operated in series or parallel configuration

Pump-out Pump: FloJet 120VAC 4.5 gpm

Power Draw: Cord #1 – 20.80Amp wide open / 13.43amp full load (Both Vacuums)
Cord #2 – 15.80Amp max total (14.30 Solution Pump /1.50 Pump-Out)

Standard Equipment

MX3-1200 High Pressure Extractor

Vacuum Connection: 2" Barb or 2" Male Flash Cuff with 2" Male NPT

Vacuum Hose: 25' X 1-1/2" with 1-1/2" cuff & 2" cuff
4' x 1-1/2" with 2" cuffs
2" Female Flash Cuff x 1-1/2" hose adapter
Hydro-Filter II Inline Filter - AC10

HP Solution Hose: 25' x 1/4" with 1/4" male & female quick connects

Accessory Mount Hardware: Four 1/4-20 x 5/8" SS Screws & Washers

Auto Fill System with chemical draw:

Metering Tip Kit: 14 different tips for changing chemical dilution rate

Water Supply Hose: 50' x 3/8" with 1/4" female quick connect &
Female garden hose fitting

Auto Pump-out System:

Pump-out Hose: 50' x 3/4" with male & female garden hose fittings

Power Cords: 2 – 25' x 12gauge with male & female plug ends

Electrical: Dual Circuit Indicator
20amp Pump Circuit Breaker
Internal Component Cooling Fan

Additional / Optional Equipment

Carpet Wand:	AW29
Wand Glide – Delrin for AW29 Wand	AW529D
Wand Glide – Teflon for AW29 Wand	AW529T
18” Bottom Velcro Strap for Wand Holder	NM5841
Foam Downer:	AH17
Hose Hook:	AH95
SX-15 Hard Surface Tool:	AW105
Gekko Handle Assembly:	AR51A
Gekko 4” Grout Tool Head:	AR51D
SX-7 Tool Head:	AR51G
Gekko Hand Tool:	AR53
1-1/2” Vacuum Hose: (Sold per foot – No cuffs)	AH36
2” cuff for 1-1/2” Vac Hose:	AH46
1-1/2” cuff for 1-1/2” Vac Hose:	AH42
1-1/2” Hose Connector PVC:	AH74
HP Solution Hose 1/4” X 25’ w/M-F Quick Connects	AH79D
1/4” Male Quick Connect:	AH102B
1/4” Female Quick Connect:	AH101B
Pump-out Hose:	AH65
Hydro-Filter II:	AC10
Replacement Screen for Hydro-Filter II:	AC10C
Metering Tip Kit:	PDE001
10/3 X 25’ Power Cord:	1696-6412
12/3 x 50’ GFCI Power Cord:	NM4407A
Belt Pack	AX108



AX108



AW29

AW105

AR51G

AC10

AR51D

AR51A

NM4407A

AR53

Safety

⚠️ WARNING

This machine is an electrical appliance.

Care must be taken to reduce the risk of electrical shock.

READ AND UNDERSTAND ALL INSTRUCTIONS BEFORE OPERATING THE MX3-1200.

- To reduce the risk of property damage or injury, repairs to electrical systems should only be performed by experienced technicians. Contact your distributor for assistance. Unplug machine power cord from outlet before performing any repairs on the extractor.
- This machine shall be grounded while in use to protect the operator from electric shock. The machine is provided with a three-conductor cord and a three-contact grounding type attachment plug to fit the proper grounding type receptacle. The green (or green and yellow) conductor in the cord is the grounding wire. Never connect this wire to other than the grounding pin of the attachment plug.
- This machine is for use on a nominal 120-volt circuit and has a grounding plug that resembles the plug illustrated in the sketch to the right. Make sure that the machine is connected to an outlet having the same configuration as the plug. No plug adapter should be used with this machine.
- The power cords supplied with this machine are properly sized to handle the electrical load of this machine and properly grounded as described above. Any extension cords used with this machine must be similarly sized with an equal or greater load rating and grounded to assure safe operation. A properly sized or rated GFCI protected cord can be used for additional protection.
- The two power cords must be plugged into separate circuits during operation. The Dual Circuit Indicator will ensure that the two cords are operating on different circuits (see Page 9 for details.)
- Do not use the MX3-1200 outdoors, in standing water or on wet surfaces. Do not store the MX3-1200 in wet conditions. If extractor is leaking, unplug machine power cords from outlets before approaching or touching machine.
- Do not unplug power cord by pulling on the cord. Grasp the plug end when unplugging the cord. Do not pull the extractor by the cord. If cord or plug is damaged, do not use cord. Replace with new cord or repair as needed before use.
- Overloaded circuit may not always trip circuit breaker. Reduced voltage to a machine on an overloaded circuit will prevent components from operating properly.

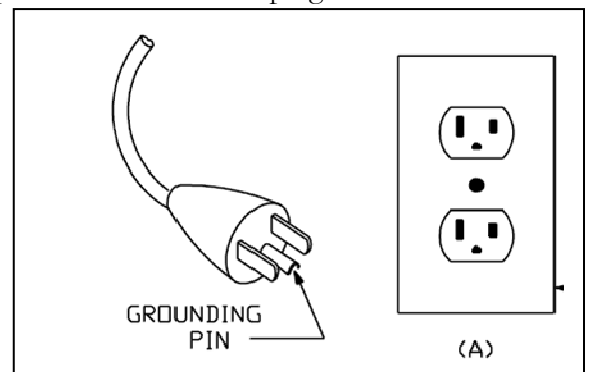

NOTICE

This machine must be protected from conditions which may damage the pump, tank, hoses and other components.

- **Freezing of water in this machine will cause serious damage.** The MX3-1200, solution hoses, and tools must be protected from freezing temperature. Store, transport, and use this equipment only in temperatures well above freezing. (32°F or 0°C). If you suspect the MX3-1200 has been frozen, do not plug in or turn on machine until you are sure it has thawed completely.
- If the equipment cannot be stored or transported in a warm environment, it can be guarded from freezing by running an anti-freeze solution through the incoming water lines, chemical feed system, solution pump, solution lines, tools and pump-out pump. The machine is filled at the factory with anti-freeze to eliminate damage during shipment in cold weather.
 - The anti-freeze solution must be completely flushed from the machine before it is returned to service.
- The MX3-1200 must not be used to pick up flammable or combustible materials or used in areas where these materials may be present.
- Solvent-based or water-based solutions containing solvents may damage the pump, hoses, and other components. Do not assume chemical compatibility. Contact your distributor or Hydro-Force if you have questions regarding the compatibility of your chemicals with the machine.
- Do not clean with solutions that are at temperatures above 140°F.
- Rinse the solution tank, chemical system, and pump with fresh water after each day's use.
- Do not allow pump to run dry. Always maintain adequate solution level to supply solution pump.
- HP hoses may rupture if worn or damaged. Do not use HP solution hoses if hose covering is cut, bulging, or otherwise damaged. Examine HP solution hoses daily and replace or repair hoses as needed.
- Use Hydro-Filter II and clean the recovery tank daily to keep pump-out filter and pump from becoming clogged. Store the MX3-1200 with the recovery tank lid open.
- Keep Vacuum Inlet Filter clean and check float for proper operation. Do not operate the MX3-1200 without the Vacuum Inlet Filter in place. **Use defoamer to eliminate foam build-up during cleaning and prevent foam/moisture from entering vacuums.**

WARNING

Use common sense to protect yourself and others while using this equipment.

- Keep pets and children away from the machine when in use.
- Keep all body parts, hair, and loose clothing away from openings and moving parts. Always wear appropriate work clothing and safety equipment when operating unit.
- Use extra care when cleaning on stairs. Wet carpet on stairs can be slippery.
- Do not move the MX3-1200 up or down stairs when tanks are full of water. Drain solution and recovery tanks, and secure base latches before moving unit up or down stairs. Lift using only the machine handles designed & designated for moving and lifting.
- Water may be spilled, drip, or be exhausted from vacuums during operation. Place unit in area where water will not cause damage or use drop cloth to protect surfaces.

Vacuum Connections

The MX3-1200 has a unique vacuum system which allows you to connect your vacuums in either parallel or in series. Vacuum connections can be changed quickly, with only a screw driver. While there is debate on which vacuum alignment provides the best extraction, this much is true:

- Two vacuums in series: The vacuum lift is increased by 1.6 times the rating of a single vacuum, while the air flow stays the same as a single vacuum.
- Two vacuums in parallel: The vacuum air flow is increased by 2.0 times the rating of a single vacuum, while the lift stays the same.

Air flow is usually measured in cubic feet per minute, indicated as CFM.

Lift is usually measured in inches of water column, indicated as "H2O or "WC.

To connect vacuums in parallel:

1. Connect the discharge / exhaust hose from vacuum #1 to the exhaust pipe on machine base.
2. Place the rubber stopper into the vacuum inlet port of vacuum manifold number two.
3. Open vacuum gate valve and attach the Gatekeeper to prevent accidental valve closure.

When connected in parallel, both vacuums must be running during cleaning. Vacuums cannot be operated individually.

To connect vacuums in series:

1. Connect the discharge / exhaust hose from vacuum #1 to the vacuum inlet port of vacuum manifold number two.
2. Place rubber stopper into the exhaust pipe on machine base.
3. Remove Gatekeeper and close vacuum gate valve.

When connected in series vacuums can be operated individually if desired during cleaning.

NOTICE Always secure the Gate Valve Open with the Gatekeeper when connecting the vacuums in Parallel. Closing the Vacuum Gate Valve with the hoses connected in the Parallel configuration may cause damage to Vacuum #2.

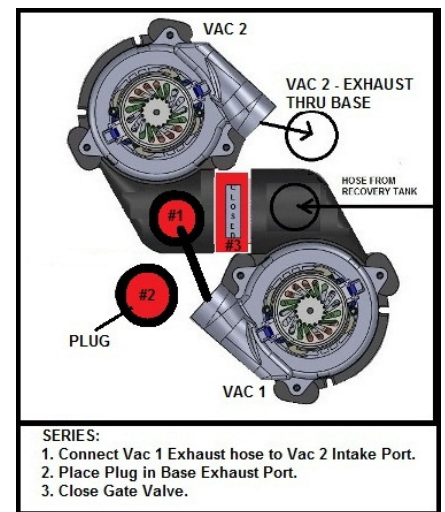
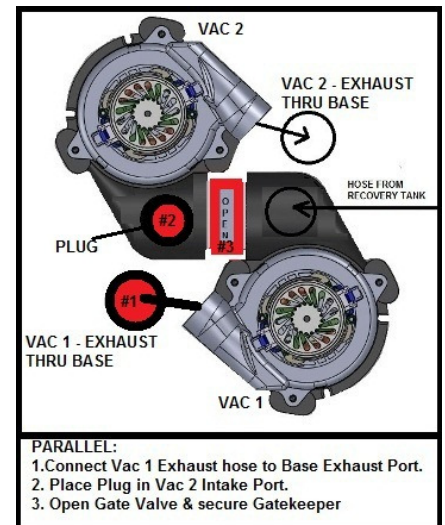

Operation Procedures

Knowledge of the proper operation of the MX3-1200 is required to ensure user safety and efficient performance of the extractor.

SET UP AND OPERATION

1. Electrical Cords:

Two 50' power cords are supplied with the Nautilus MX3-1200. Cord #1 powers both vacuum motors and the cooling fan; Cord #2 powers the high pressure solution pump and the waste pump. The amperage required by each cord requires that the two cords be plugged into two separate 20amp circuits:

- Cord #1 (Left side) will supply power to both vacuums.
- Cord #2 (Right side) will supply power to the Solution Pump and Pump-out Pump.

While the machine may be able to run for a short time when both cords are connected to separate 15amp circuits, component power draw will require two separate 20amp circuits for continuous operation.

20amp circuits are usually found in kitchens and bathrooms.

Make sure no other items are plugged into these circuits. An overloaded circuit will not always trip the circuit breaker immediately, but it may not provide sufficient voltage for proper operation and the breaker may trip eventually.

Plug the two power cords into two outlets from different circuits. If the Dual Circuit Indicator green light fails to light, you may be on the same circuit and may need to select a different plug for one of the cords. If the Dual Circuit Indicator green light comes on, you are plugged into two different circuits. Proceed with your set-up procedure.

(Dual Circuit Indicator light may take up to 30 seconds to recognize the two circuits and turn ON.)

If a circuit breaker trips or the pump circuit breaker trips during operation, reset the breakers and move the cord to another outlet as needed.

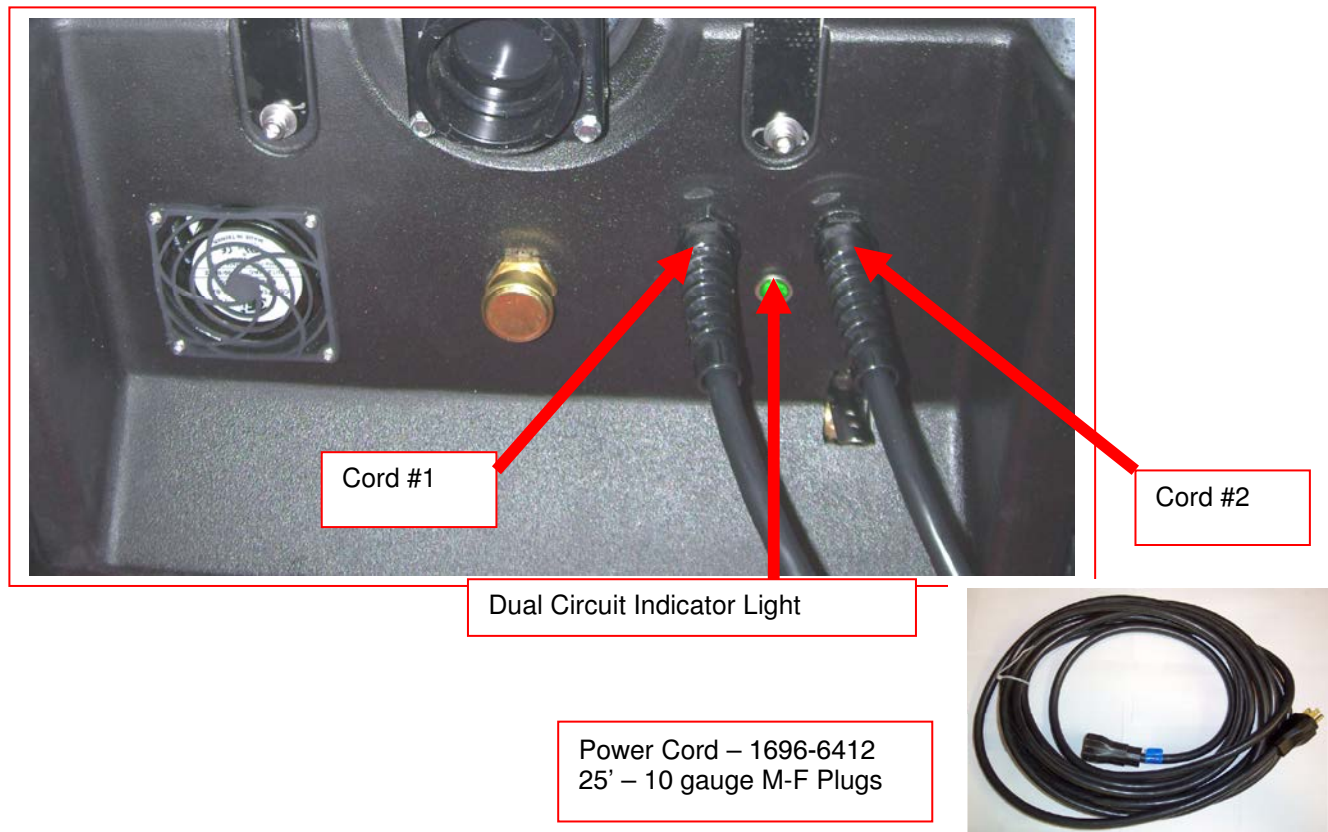

2A. Water Supply & Chemical Mixing– Manual Fill:

- Pour up to 12 gallons of hot water into the solution tank at the front of the machine. **The water temperature cannot exceed 140°F.**
- Measure and add the appropriate amount of the desired liquid chemical to the water in the solution tank. The amount of chemical will vary depending on the type of chemical used, the amount of water in the tank, and the material being cleaned; consult the chemical packaging for specific mixture ratios.
- Powdered chemicals should be dissolved in water before adding to the water in the solution tank.

NOTICE **DO NOT RUN OUT OF WATER WHILE USING THE MACHINE!** Ensure that the tank contains enough water to complete each job. If the water level is low: stop cleaning, turn off the pump, and refill the tank. Running the pump dry will damage the pump and void the warranty.



Pour appropriate amount of hot water into solution tank



Add appropriate amount of chemical to water in solution tank

2B. Water Supply & Chemical Dilution – Auto-Fill:

- The chemical dilution rate is controlled by the metering tip, and the dilution rate can only be changed by changing the metering tip (See “How to Change the Metering Tip” on Page 11 for instructions.)

Chemical Feed Setup:

- Remove the chemical feed hose from the solution tank. Make sure float is attached to valve and hanging freely, above the bottom of the solution tank. Adjust float height to maintain adequate water level.
- Place the end of the chemical feed hose into a container of liquid chemical.
- If the tip is removed, and the proportioning system operated with no tip, the dilution rate will be 8:1 (the equivalent to adding 16-1/4oz of chemical to each gallon of water.)
- The standard tip for use with the MX3-1200 is the turquoise tip with a dilution rate of 256:1. This means that for each gallon of water flowing into the machine, 1/2 ounce of chemical will be added.
- **If a fresh water rinse with no chemical is desired, simply leave the chemical feed hose inside the solution tank.**

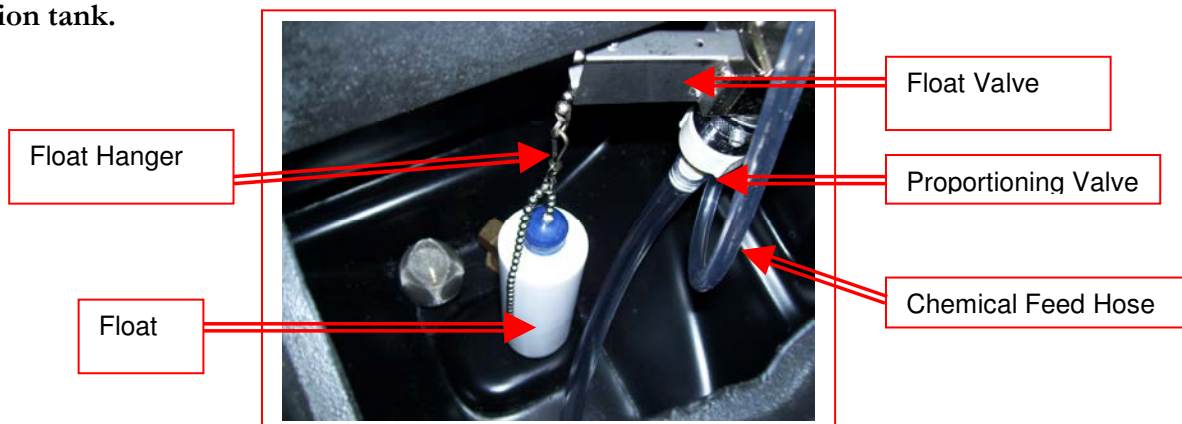

How to Change the Metering Tip:

- Remove the chemical feed hose from the barb on the side of the proportioning valve.
- Unscrew and remove the old tip.
- Screw in the proper tip for your chemical tip and place the hose back on the barb

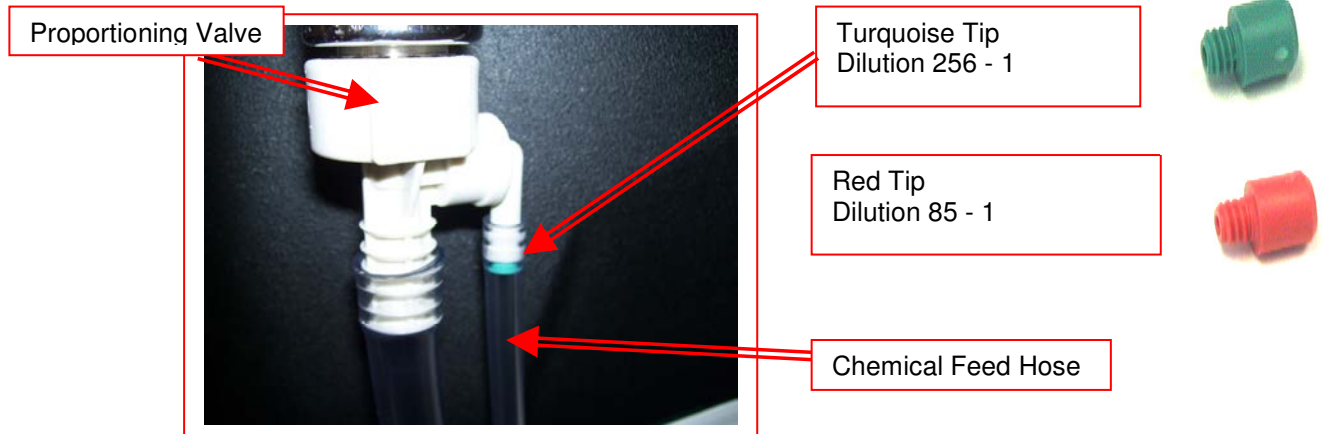

Metering Tip Kit (Hydro-Force Item# PDE001) contains 14 different colored metering tips, allowing dilution rates from 11:1 up to 427:1. Refer to the chart below to select the tip that meets the dilution rate for your chemical application.

- For example: if you require 1-1/2 ounces of chemical per gallon of water, change to the red metering tip with the dilution rate of 85:1.
- The dilution rates are based on chemicals with water-like viscosity. Thicker (more viscous) chemicals will dilute at a different rate.
- For powdered chemicals, a liquid concentrate must be made. Mix the concentrate according to the manufacturer’s directions, and then select the appropriate metering tip.
- Contact your distributor or Hydro-Force if you have questions about your chemical.

Metering Tip Application Chart:



Metering Tip Kit – PDE001

TIP COLOR	CHEMICAL DILUTION RATES OZ / GAL (RATIO)	
TAN	0.30	(427:1)
ORANGE	0.40	(320:1)
TURQUOISE	0.50	(256:1)
PINK	0.75	(170:1)
LIGHT BLUE	1.00	(128:1)
BROWN	1.12	(114:1)
RED	1.50	(85:1)
WHITE	1.75	(73:1)
GREEN	2.00	(64:1)
BLUE	2.50	(51:1)
YELLOW	3.75	(34:1)
BLACK	5.00	(26:1)
PURPLE	8.50	(15:1)
GRAY	11.50	(11:1)
NO TIP	16.25	(8:1)

Water Supply:

- Once the correct metering tip is in place:
 - Connect the Auto-Fill Water Supply Hose to the water inlet (the male quick-connect on the front of the machine.)
 - Connect the other end of the hose to a water faucet, and then turn on the water.
- Hot water can be used as long as the temperature does not exceed 140°F.
- Faucet adapter kits (Hydro-Force item #AX21 & AX22) are available that allow connection to different types of faucets if needed.



Connect the Auto-Fill Water Supply Hose to a faucet and turn on the water



Connect the Auto-Fill Water Supply Hose to Solution Inlet (Male quick connect on the front of the machine.)

3/8" id X 25' with F Quick Connect & F Garden Hose Fitting

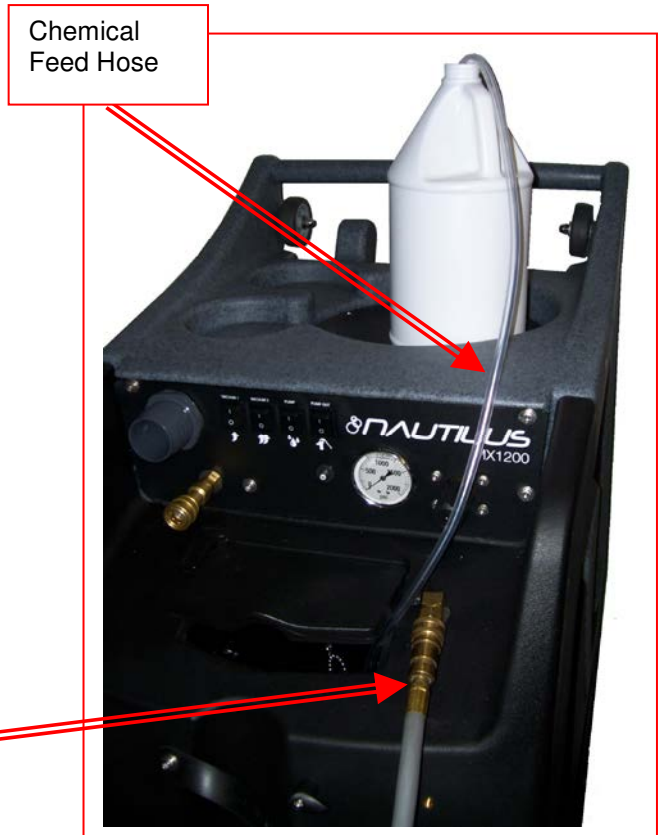

Chemical Feed Hose

Float Valve

To adjust the water level in the solution tank:

- Turn off the water supply.
- Adjust the length of the chain connecting the float bottle to the float valve. Unhook the float from the beaded chain on the valve. Unsnap the hook from the beaded chain on the float.
 - Move the bottle down to decrease the water level.
 - Move the bottle up to increase the water level.
- Snap the back onto the float chain & hook the float back onto the valve chain.
- Turn the water supply back on.

If the chemical is not drawing, or if the tank is not filling or is overflowing, refer to the trouble shooting guide, or contact your distributor for assistance.

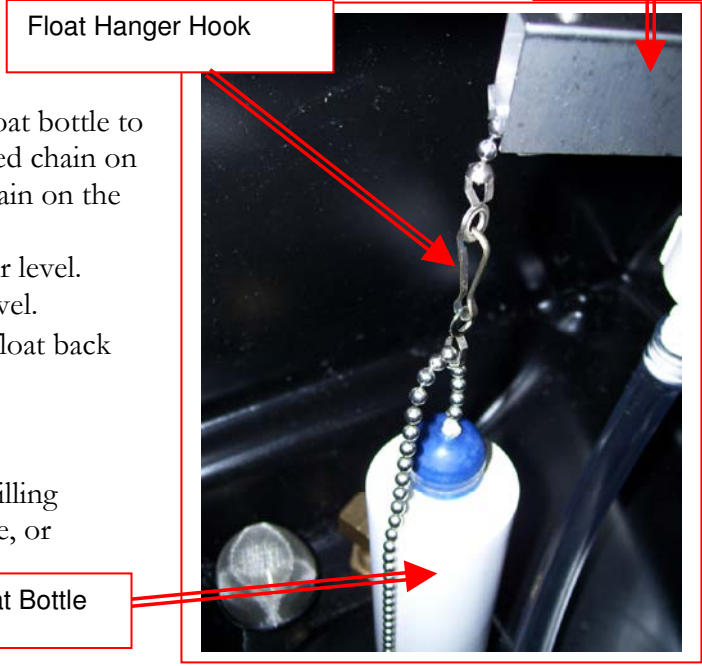

Float Hanger Hook

Float Bottle

3. Connection of Solution Hose:

Connect the high pressure solution hose to the solution outlet (female quick connect on the front of the machine). Connect the other end of the hose to the male quick connect on the cleaning tool. When you are ready to start cleaning, turn the solution pump switch to the ON position



HP Solution Hose Assembly – AH79D
1/4" id X 25' with M-F Quick Connects



Connect the male end of the HP Solution Hose Assembly to the female solution outlet fitting on the machine. Connect the female end to the cleaning tool.

4. Priming the High-Pressure Pump:

Before priming the pump, make sure your solution hose and tool are connected to the machine.

Once water is in the solution tank, the high pressure pump must be primed:

- There is a prime valve located on the lower back portion of the machine.
- Turn on both vacuums and the solution pump. Press the priming lever for a few seconds while you block off the vacuum inlet with your hand. The vacuum will pull solution through the pump and prime valve into the vacuum tank.
- Let off the prime valve and your pump is primed. As long as there is solution in the tank the pump should remain primed. You can now proceed with cleaning or turn the pump off and continue your set-up.

If the pump still does not prime, or if flow is low or unsteady, check the hose from the solution tank to the pump (as well as the filter) for clogging, kinks, or restrictions. Clean or replace hose and/or filter and repeat the priming procedure.

If you are having trouble with the pump, refer to the trouble shooting guide or contact your distributor for advice or assistance.

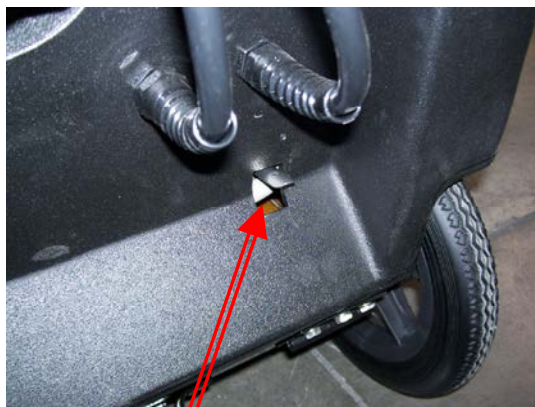

PUMP PRIMING VALVE



PRESSING THE PUMP PRIMING VALVE

TO PRIME THE SOLUTION PUMP:

1. **TURN ON BOTH VACUUMS**
2. **TURN ON THE SOLUTION PUMP**
3. **BLOCK OFF THE VACUUM PORT**
4. **PRESS THE PUMP PRIMING VALVE**



BLOCKING THE VACUUM PORT TO PRIME THE PUMP

5. Connection of Vacuum Hoses:

The vacuum connection on the machine can be either a 2" hose barb or 2" male Flash Cuff. Both are included with your MX3-1200. The desired connector can be threaded into the vacuum port on the front of the machine.

A 2" female Flash Cuff 1-1/2" hose adapter is also included to connect the 1-1/2" vacuum hose to the 2" male Flash Cuff on the machine.

A 2" hose cuff for 1-1/2" vacuum hose is included to connect the 1-1/2" vacuum hose to the 2" hose barb on the machine.

There are three components used to connect the cleaning tool to the vacuums and recovery tank:

1. A short 4' vacuum hose: Connect one end to the 2" vacuum barb or 2" male Flash Cuff to the front of the machine using the appropriate cuff and the other to the outlet side of the Hydro Filter.
2. A Hydro Filter II inline filter.
3. A 25' Vacuum Hose: The 2" cuff on the 25' vacuum hose is connected to the inlet side of the hydro filter. The other end with the 1-1/2" cuff is connected to the cleaning tool.

When ready to begin cleaning, turn both vacuum switches to the ON position. If connected in series, the MX3-1200 can be operated with only one vacuum for cleaning delicate fabrics. (See Vacuum Connection instructions on Page 8) In most situations you will turn both vacuum switches ON.

Vacuum Hose
1-1/2" x 25' with 2" & 1-1/2" cuffs

Hydro-Filter II – AC10



Short Vacuum Hose
1-1/2" x 4' with 2" Cuff & 2" female Flash Cuff adapter

6. Connection of Pump-out Hose:

The pump-out hose is a 50' section of 3/4" garden hose. (Use of smaller diameter hose may reduce flow.)

- Remove the cap from the pump-out outlet fitting on the back of the machine.
- Connect the pump-out hose to the outlet fitting.
- Place the other end of the hose in a commode or drain connected to the sanitary sewer system.
- Secure hose end to prevent movement during pumping.

NOTICE

- Use defoamer to prevent foam build-up in recovery tank during cleaning and to keep foam/moisture from entering vacuums.
- Use Hydro Filter II inline filter to trap and remove debris from the waste water before it enters the recovery tank. Excess debris in recovery tank may clog Pump-Out filter. Clean Filter as needed during use.
- Do not turn the Waste Pump switch ON unless pump-out hose is connected and has been routed to a proper drain.
- The Waste Pump does not use a float switch and will run as soon as the Waste Pump switch is turned ON. It is made to run continuously while cleaning, as this type diaphragm pump can run dry without damage.

When ready to begin cleaning, turn the Waste Pump switch to the ON position.



Pump-out Filter

Connect the Female Garden Hose Fitting end of the Pump-out Hose to the outlet fitting on the back of the recovery tank. Place the other end of the pump-out hose in a sanitary drain.



If not using the waste pump-out, the pump-out hose does not need to be connected. When the recovery tank fills during cleaning, the float assembly in the vacuum inlet filter will rise and will automatically shut off the vacuum air flow to prevent the recovery tank from overflowing and waste water from getting into the vacuums. When this occurs:

- Immediately shut off the vacuum switches.
- Drain the recovery tank.
 - Turn off the pump switch while draining the tank.
 - Turn pump switch back upon resumption of cleaning.
- Close the drain valve and turn the vacuum switches back on when ready to resume cleaning.

If the pump-out or vacuum shutoff is not working properly, refer to the trouble shooting guide or contact your distributor for advice or assistance.



Float Shutoff Assembly



Draining the Recovery Tank

7. Pressure Adjustment:

To make it easier to check and adjust the pressure, the pressure gauge and the pressure regulator/unloader are mounted on the control panel on the front of the machine. When the high-pressure solution pump is on and primed, pressure will show on the gauge only while the tool is being sprayed. When the tool is sprayed the gauge will display the pressure being delivered to the tool. When the tool is not being sprayed the gauge will return to zero.

- To decrease the pressure, turn the black knob on the pressure regulator/unloader to the left (counter-clockwise.)
- To increase the pressure, turn the black knob on the pressure regulator/unloader to the right (clockwise.)
- To adjust pressure to your tool and surface requirements:
 - Spray the tool.
 - Check the pressure on the gauge.
 - Re-adjust as needed to set the machine at the desired pressure.
 - Choose the pressure setting that best meets your type of cleaning.

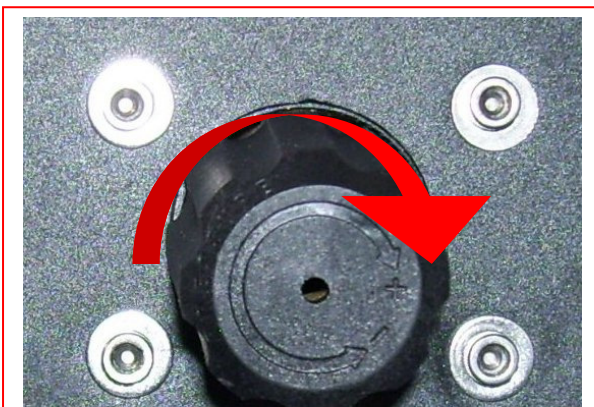

To increase the solution pressure, turn the regulator/unloader knob clockwise.

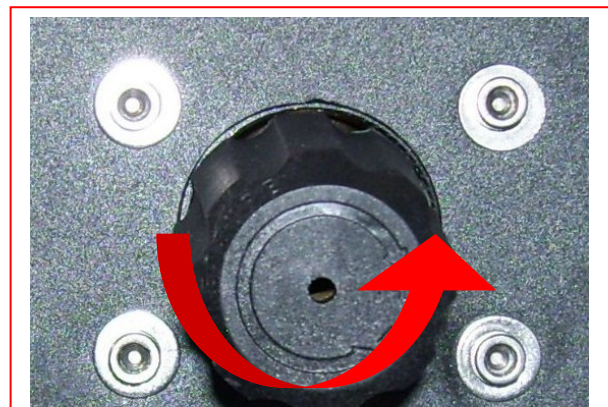

To decrease the solution pressure, turn the regulator/unloader knob counter-clockwise.

The maximum pressure setting is 1200psi; however, the highest pressure attained is dependent on the amount of water flow at the tool:

- Smaller jets and lower flow will allow for higher pressure at the tool.
- Larger jets and higher flow will lower the maximum pressure attained at the tool.

The desired setting will depend on the type of cleaning and tool used. For example:

- Carpet Cleaning with 2-jet AW29 wand: 400psi
- Tile Cleaning with SX-15: 1000psi

If adjusting or maintaining pressure becomes a problem, refer to the trouble shooting guide or contact your distributor for advice or assistance.



Pressure gauge & Regulator/Unloader

Shutdown Procedures:

- If using the auto-fill system, turn the water supply off before finishing each job. This will allow use of the water and chemical already in the tank, and will reduce the amount of excess water to be disposed of later.
- When finished cleaning, turn off all switches.
- If the auto-fill system was used and there is still water in the solution tank, push the float down to release the water inlet hose pressure before disconnecting the hose from the faucet. Disconnect the water inlet hose from the quick-connect on the front of the machine.
- Disconnect the solution hose and vacuum hose from the cleaning tool. Pull valve trigger to release pressure from the hose before disconnecting solution hose from cleaning tool.
- Disconnect the Hydro-Filter II from the vacuum hoses and clean the filter as needed. Replacement filter screens are available (AC10C.)
- Disconnect the vacuum hose and solution hose from the machine.
- If water remains in the solution tank, use the short vacuum hose and vacuum the excess water from the tank.
- If the auto-fill system was utilized, place the chemical feed hose back into the solution tank.
- If the waste pump-out system was used:
 - Turn the waste pump switch “on” to pump out any remaining water from the recovery tank.
 - Turn switch off, remove the pump-out hose from the outlet fitting and replace the cap.
 - Roll up hose toward drain to remove remaining water from hose.
 - Connect ends of hose together to prevent dirty water from dripping from hose during transport.
- Disconnect the power cords from the outlets and from the machine.
- Remove the float shutoff assembly from the recovery tank and clean vacuum shutoff filter as needed. Clean Pump-Out filter screen. Replace shutoff assembly and tank lid.
- Drain any remaining water from the recovery tank and dispose in sanitary drain. Do not use the same bucket to drain the tank that you use to fill the tank.
- Roll up all hoses and cords. Collect and store extractor, all tools, and accessories.

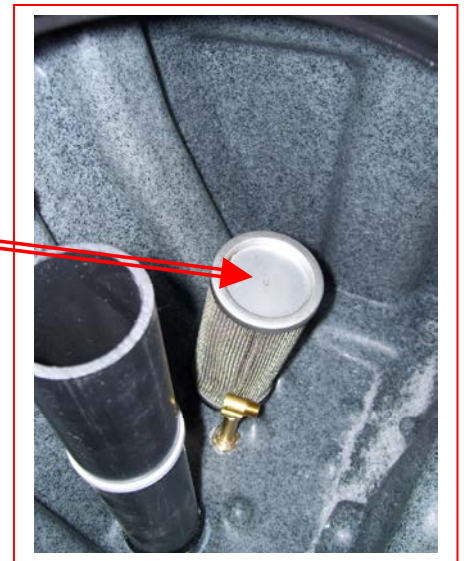

Accessory Storage Options:

The MX3-1200 is designed to make it easier for the operator to transport the machine and the most common cleaning accessories.

Bucket & Sprayer Storage

The top of the MX3-1200 is sized and recessed to hold a five gallon bucket or two one-gallon chemical bottles as well as two 2QT sprayers.

Power Cord Storage

The back of the MX3-1200 has two sets of cord wraps to hold two 10/3 x 25' power cords.

Carpet Wand Storage

The front of the MX3-1200 is designed to hold a S-Bend Carpet wand and has two straps to hold it securely. Optional strap for larger wands available

Other Storage

Each side of the MX3-1200 has a set of molded in threaded inserts to which holders can be attached to hold other accessories or supplies making it much easier to move around. Four 1/4-20 x 5/8" mounting screws & washers included.



Wand Holder Straps

Molded in Threaded Inserts
for Side Mount Holders



Troubleshooting

Troubleshooting – Nautilus MX3-1200

Problem	Cause	Solution
Machine not turning on - No power	Building circuit breaker tripped.	Reset breakers or move cords to other outlets
	Faulty power cord	Replace cord (1696-6412)
	Faulty switches or internal wiring	Check wiring & test switches - Repair as needed *
Solution Pump not running	Building circuit breaker tripped.	Reset breakers or move cords to other outlets
	Pump circuit breaker tripped	Reset breaker – Check available circuit power & pump
	Faulty power cord	Replace cord (1696-6412)
	Faulty switches or internal wiring	Check wiring & test switches - Repair as needed *
	Pump motor breaker tripped	Push in reset button on pump motor &/or external breaker
	Pump motor faulty	Replace pump motor (PT059)
	Pump seized - trips breaker	Repair or replace pump head & bearing (PT058) - Check motor and/or replace complete pump & motor assy. (AP48)
Low Solution Pressure Low and/or Pulsating	Jets too large for pressure desired	Check jets size & flow rates use smaller jets or lower pressure
	Jets worn allowing too much flow	Replace Jets
	Solution inlet filter plugged	Clean or replace filter
	Hose from solution tank restricted	Repair or replace hose
	Pump intake hose or fittings leaking	Repair or replace hose. Tighten clamps or replace fittings
	Pressure regulator sticking	Lube o-rings on regulator shaft – PAGE 33
	Pressure regulator faulty	Repair or replace pressure regulator / unloader (PT017)
	Filter screen or jets plugged on tool	Clean out filter or jets
	Solution tank empty	Add water to tank - Check & repair auto fill assembly
	Pump not primed	Perform pump priming procedure
	Priming Valve stuck open	Repair or replace the Priming Valve
	Pump faulty	Repair or replace pump (PT059 or AP48)
	Pressure Gauge faulty	Replace gauge (PT063)
	Tool valve faulty	Repair or replace valve
	Quick connects or hoses restricted	Clean out or replace quick connects and/or hoses
Can't connect solution hose to machine	Pressure in lines	Release pressure
	Quick connects faulty	Replace quick connects (AH101B, AH102B)
	Wrong style/size quick connects	Replace quick connects to match connects on machine
<p>⚠WARNING : To reduce the risk of fire electrical shock or injury repairs to wiring should only be performed by experienced service technicians. * If you are not experienced in checking electrical wiring contact your nearest authorized service center to perform tests and repairs to wiring and switches.</p>		

Problem	Cause	Solution
Dual Circuit Indicator Not Lighted	Cords on the same circuit	Move one cord to outlet on different circuit
	No voltage from one/ both outlets	Check circuit breakers – Reset breakers or move cords
	Light Bad	Replace Light
	Dual Circuit Indicator Bad	Replace indicator
	One/Both Outlets Wired wrong	If hot & neutral sides switched on outlet, machine will work, but light will not turn ON.
Pump-out not working	Building circuit breaker tripped.	Reset breakers or move cords to other outlets
	Faulty power cord	Replace cord (1696-6412)
	Faulty switches or internal wiring	Check wiring & test switches - Repair as needed * (NM5714)
	Pump-out pump faulty	Replace pump-out pump (AP37)
	Pump-out filter clogged	Clean pump-out filter - Keep recovery tank clean – Use Hydro-Filter AC10
	Discharge hose restricted	Un-kink, clean out or replace hose
	Pump-out pump clogged	Remove and clean out pump
Vacuum Motor not running	Building circuit breaker tripped.	Reset breakers or move cords to other outlets
	Faulty power cord	Replace cord (1696-6412)
	Faulty switches or internal wiring	Check wiring & test switches - Repair as needed *
	Vacuum motor faulty	Replace vacuum motor (AV010)
Loss of Vacuum	Vacuum motor faulty	Replace vacuum motor (AV010)
	Vacuum motor gasket damaged	Replace gasket (PA010)
	Recovery tank lid gasket damaged	Replace gasket (1650-5695)
	Drain valve open	Close valve
	Drain valve leaking	Repair or replace drain valve (PEA11)
	Vacuum motor hoses loose / leaking	Reconnect or replace vacuum motor hoses
	Vacuum Valve in wrong Position	Check Vacuum Gate Valve Position. – PAGE 8
	Vacuums not connected properly	See vacuum connection instructions – PAGE 8
	Vacuum hose or tool clogged	Clean out vacuum hoses and tool
	Vacuum hoses or cuffs leaking	Replace vacuum hoses, cuffs & connectors as needed
	Recovery tank full	Drain tank
	Float shutoff filter clogged	Clean float shutoff filter
	Float stuck in float shutoff	Repair or replace float shutoff
	Pump-out Pump faulty	Repair or replace pump out pump (AP37)
Recovery tank damaged	Replace recovery tank	
Chemical not feeding	Solution tank not filling	Check & repair auto fill assembly
	Chemical hose restricted	Un-kink, shorten, clean out or replace hose
	Filter screen plugged	Clean or replace filter (PDE100-11P)
	Low Incoming Water Pressure	Move bottle & shorten chemical hose to improve draw – Find other water source.
	Wrong size metering tip	Change metering tip
	Chemical proportioner faulty	Replace chemical proportioner (PDE61-22-3)
	Check valve in filter faulty	Replace filter (PDE100-11P)
<p>⚠️WARNING : To reduce the risk of fire electrical shock or injury repairs to wiring should only be performed by experienced service technicians. * If you are not experienced in checking electrical wiring contact your nearest authorized service center to perform tests and repairs to wiring and switches.</p>		

Problem	Cause	Solution
Tool won't spray - low or uneven spray	Jets clogged	Clean out or replace jets
	Inline filter clogged	Clean out or replace filter
	Jets worn	Replace jets
	Jets not aligned properly	Re-align jets
	Tool valve faulty	Repair or replace valve
	Quick connects or hoses restricted	Clean out or replace quick connects and/or hoses
Solution Tank not filling	Water source turned off	Turn on faucet or find other water source
	Float not on valve arm	Reconnect float to valve arm - Adjust to proper height/level
	Float valve faulty	Repair or replace float valve
	Water hose restricted	Un-kink, clean out or replace hose
	Water Pressure too high	Use pressure regulator on auto-fill hose
	Quick connects faulty	Clean out or replace quick connects (AH101B, AH102B)
Solution tank overflowing	Float too heavy/ Filled with water	Replace float
	Float & chain tangled	Make sure float chain free & hanging properly
	Float too high	Adjust chain to set float at proper level
	Water Pressure too high	Use pressure regulator on auto-fill hose
	Float valve faulty	Repair or replace float valve
Chemical Jug Filling with water - Overflowing	Foot valve in Filter stuck	Clean out foot valve and filter
	Foot valve in Filter faulty	Replace foot valve and filter (PDE100-11P)
<p>⚠️ WARNING : To reduce the risk of fire electrical shock or injury repairs to wiring should only be performed by experienced service technicians. * If you are not experienced in checking electrical wiring contact your nearest authorized service center to perform tests and repairs to wiring and switches.</p>		



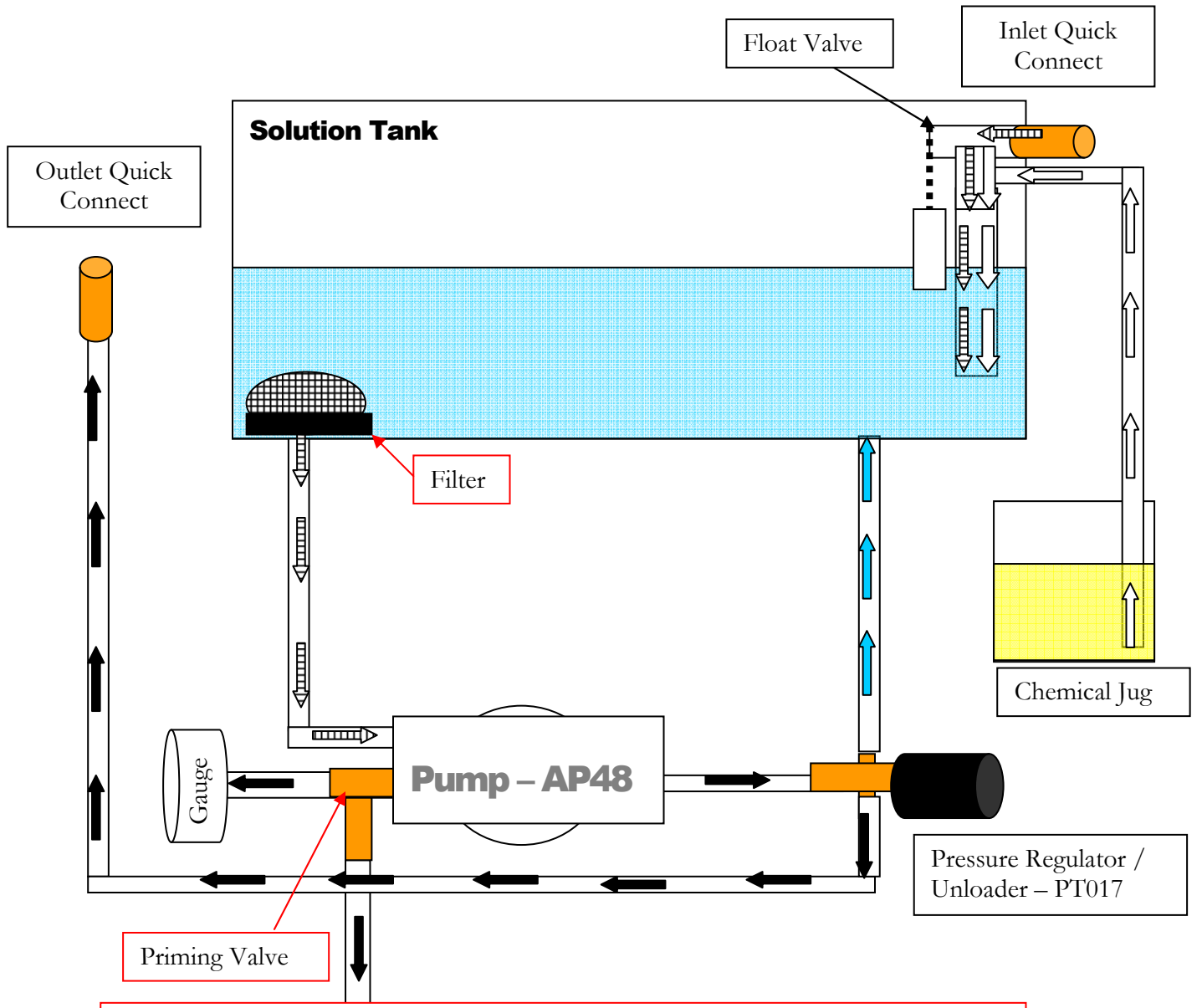

- Contact your distributor for additional troubleshooting assistance, to order parts, or for advice and assistance in performing necessary repairs.

MX3-1200

Solution Flow Path



When Priming Valve held open water flows through hose to Recovery Tank

- Denotes incoming water flow

- Denotes Water flow in high pressure hose

- Denotes by-pass water flow from pressure regulator

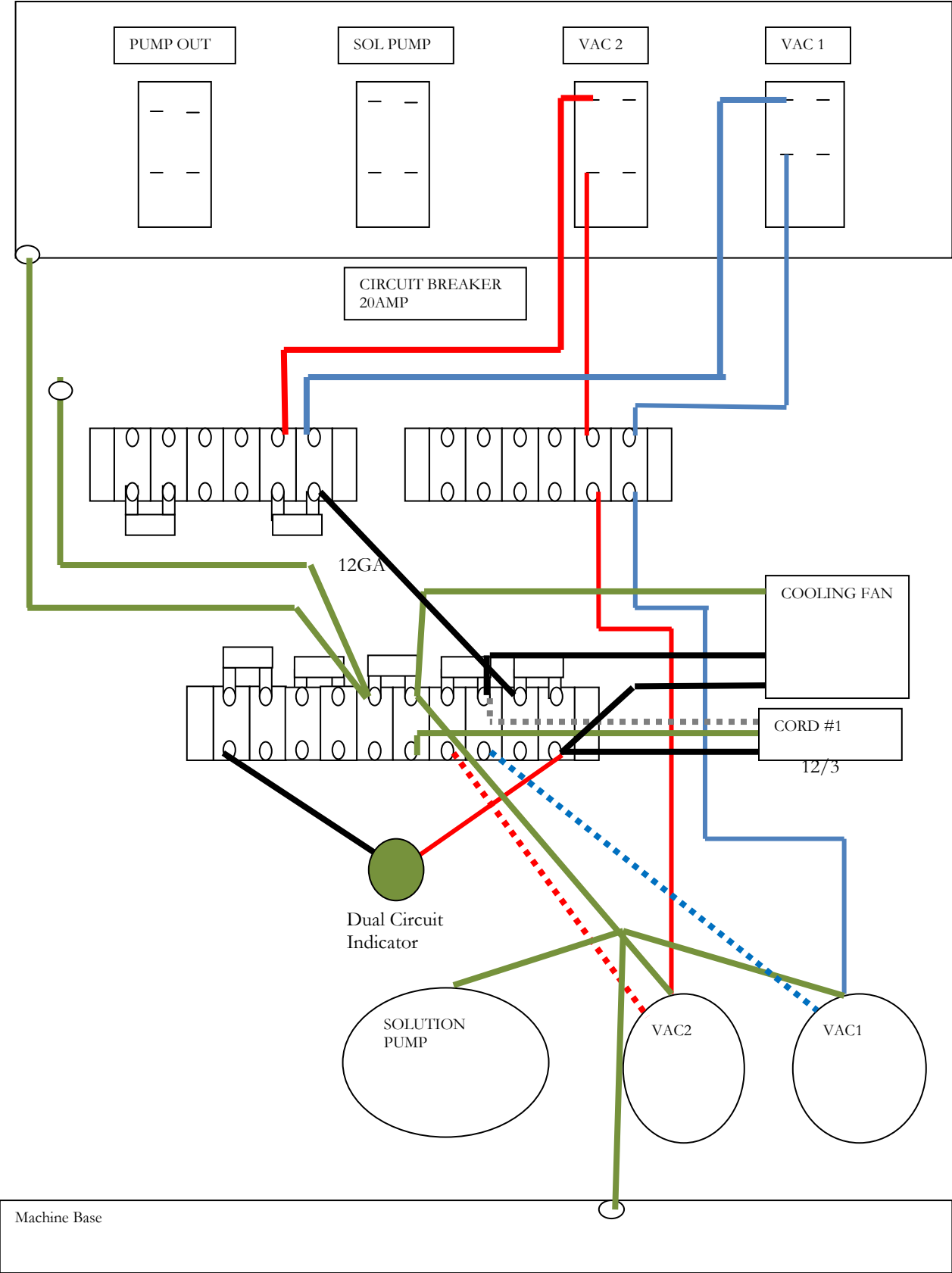
- Denotes Chemical flow

MX3-1200

Wiring Diagram – Cord #1



MX3-1200

Wiring Diagram – Cord #2

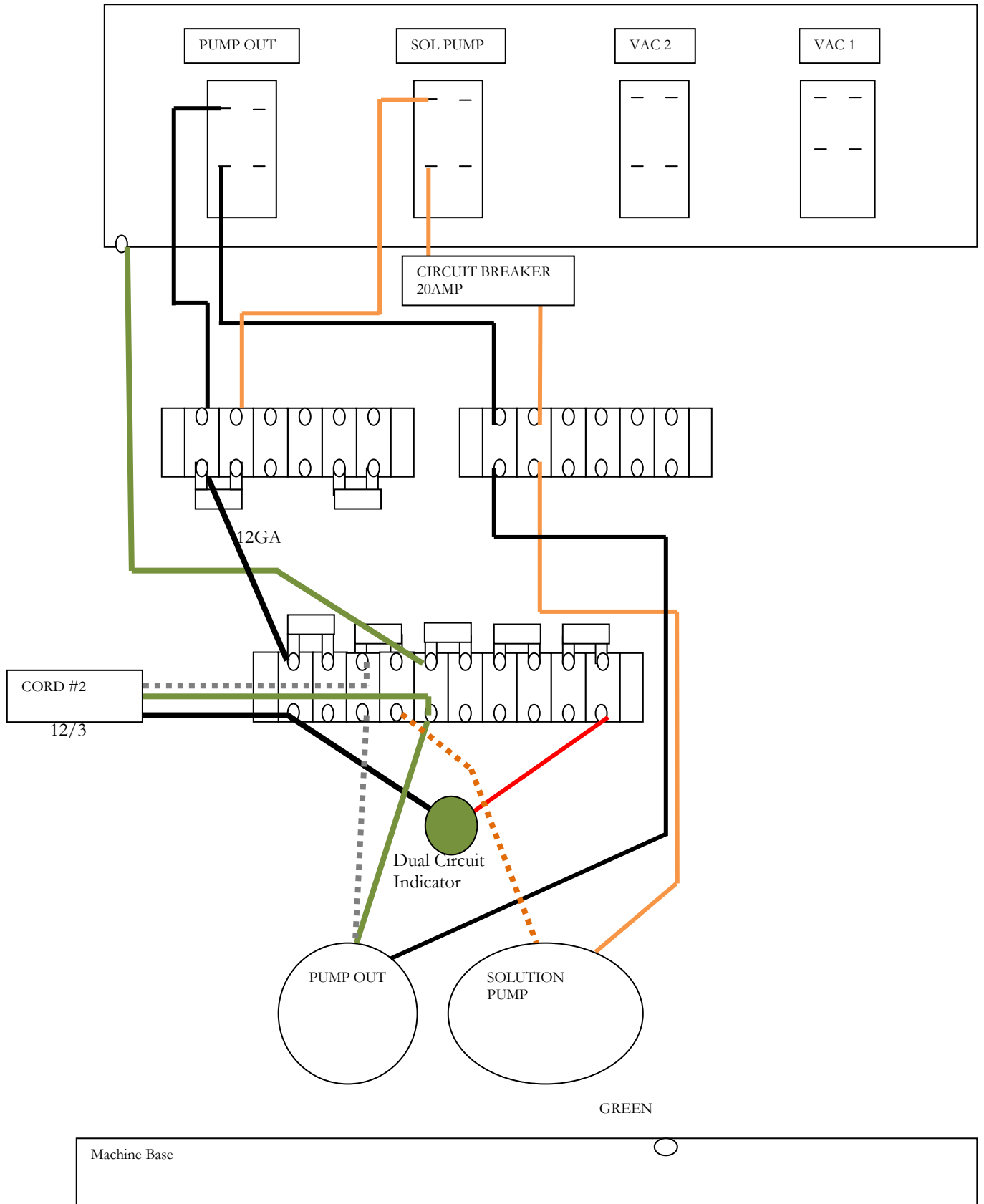

NAUTILUS MX3-1200 SWITCH PANEL:

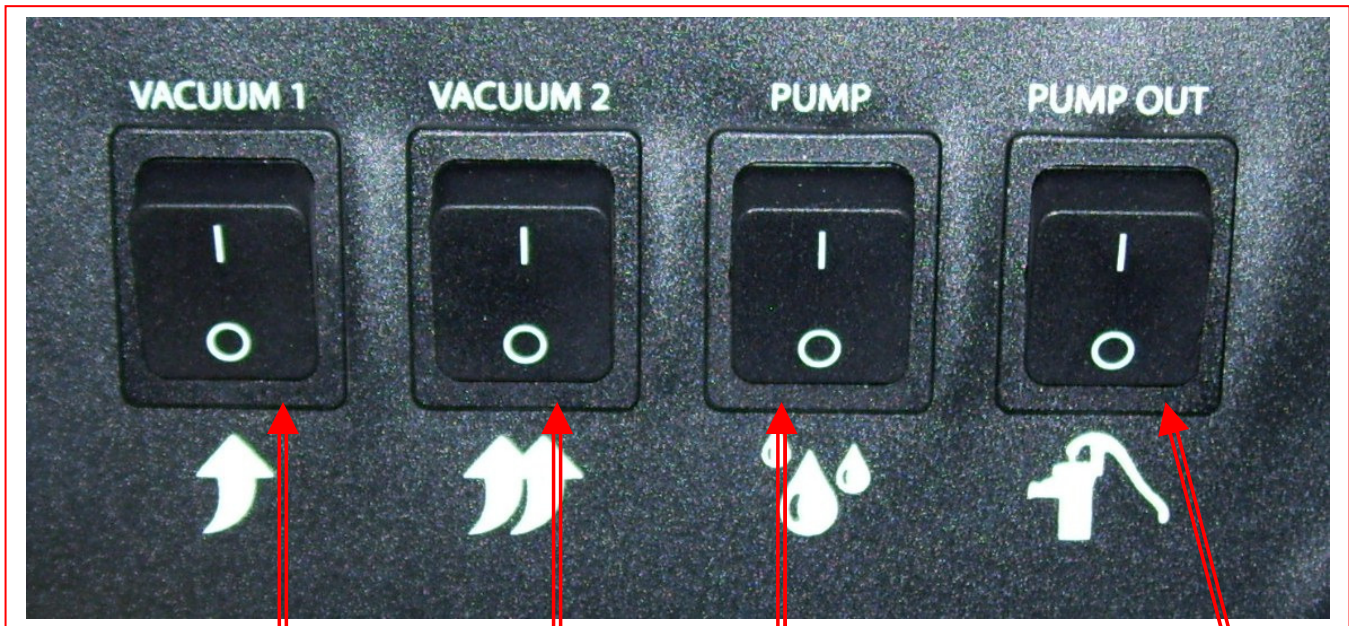

Vacuum #1 – Power from Cord #1.
When the switch is turned to the ON position power is supplied to the vacuum motor. (3-Stage Vacuum)

Solution Pump Switch – Power from Cord #2.
When the switch is turned to the ON position power is supplied to the solution pump motor. When not using solution (Extracting only) do not turn this switch ON.

Vacuum #2 – Power from Cord #1.
When the switch is turned to the ON position power is supplied to the vacuum motor. (3-Stage Vacuum)

Cooling Fan – Power from Cord #1.
The cooling fan is not controlled by any switch.
As soon as Cord #1 is plugged in the cooling fan will turn on to exhaust air from the base.

Waste Pump Switch – Power from Cord #2.

NOTICE Do not turn Waste Pump Switch ON unless a hose is connected to the Pump-out Outlet port.
For pump protection there is a pressure switch which will turn the waste pump off if the pressure in the discharge line gets too high, as it would if the pump was turned on while the outlet cap was still in place.

Maintenance

Proper maintenance is required to keep the MX3-1200 operating properly, prevent downtime and to extend the life of your equipment.

⚠️ WARNING

This machine is an electrical appliance. Care must be taken to reduce the risk of electrical shock.

⚠️ WARNING

Disconnect electrical power before performing any service or maintenance inside machine base or before testing or repairing switches or power cords. Failure to do so may result in severe personal injury or death.

OPERATION	INTERVAL	Page #
CLEAN CHEMICAL FEED FILTER & FOOT VALVE	Daily – After Each Job	28
CLEAN VACUUM SHUTOFF ASSEMBLY SCREEN	Daily – After Each Job	28
CLEAN HYDRO-FILTER II	Daily – After Each Job	29
RINSE OUT RECOVERY TANK	Daily	29
CLEAN WASTE PUMP-OUT PUMP	Daily	30
FLUSH SOLUTION TANK AND PUMP	Daily	30
CLEAN PUMP-INLET FILTER	Weekly – As needed	31
FLUSH CHEMICAL SYSTEM	Monthly	32
LUBRICATE PRESSURE REGULATOR O-RINGS	Monthly	33
CLEAN DRAIN VALVE	As needed	34
STORAGE PREP – FREEZE PROTECTION	As needed	35

CLEAN CHEMICAL FEED FILTER & FOOT VALVE:

The Filter & Foot Valve is on the end of the chemical feed hose that is placed in the chemical jug as part of the chemical feed system. Regularly examine the filter and clean as needed.

To test the Foot Valve:

- Remove the Filter & Foot Valve from the end of the chemical feed hose and rinse in fresh water.
- Blow through the valve from the filter side of the barb.
 - If the Foot Valve is functioning, air should move freely from the filter side, but will not flow from the barb side of the filter.
 - If valve is not functional, clean or replace as needed.

Heavy chemical build-up can be removed with a mild acid rinse and/or the use of a brush and compressed air.

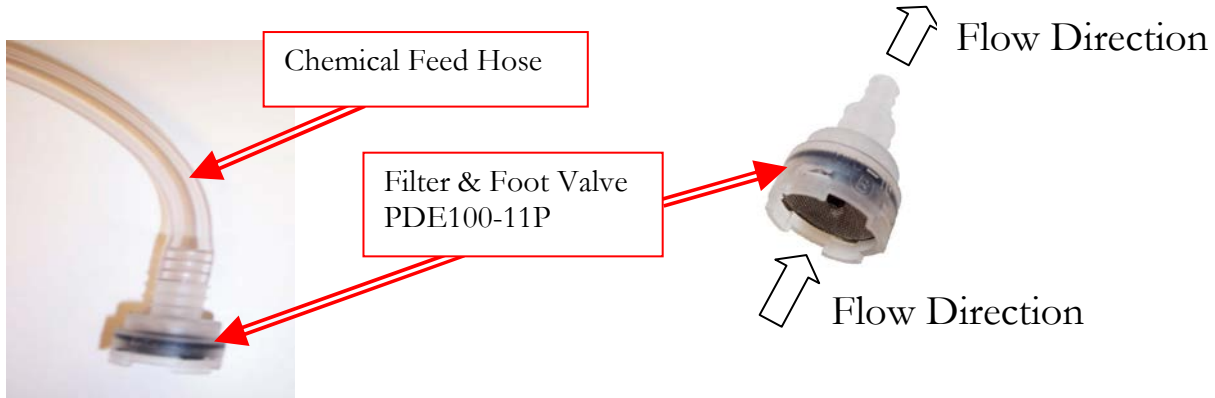

CLEAN VACUUM SHUTOFF ASSEMBLY SCREEN:

Inside the recovery tank, on top of the stand pipe, is the Vacuum Shutoff Assembly. It functions to prevent debris and water from being sucked into the vacuum motors. Operating the MX3-1200 without the Vacuum Shutoff Assembly or with a poorly maintained assembly will greatly decrease the life of the vacuum motors and will void the warranty.

If debris builds up on this filter, it will reduce the vacuum air flow and may cause a significant decrease in the rate of water recovery. If debris prevents the float from moving or seating against the Filter Cap Assembly, it may not stop the airflow when the tank fill with water, and the water will be sucked into the vacuums and blown out the exhaust.

Use defoamer to prevent foam or moisture from entering vacuums (See Page 15).

To clean:

- **Do not pull up on top of cap.** Carefully pull up from the bottom of filter cap assembly to pull the assembly off of the stand pipe. Then pull float off of riser pipe.
- Pull fibers and lint off and rinse filter cap assembly and float with clean water.
- Place the float back on the riser pipe then push the filter cap assembly back onto the stand pipe and replace the recovery tank lid.

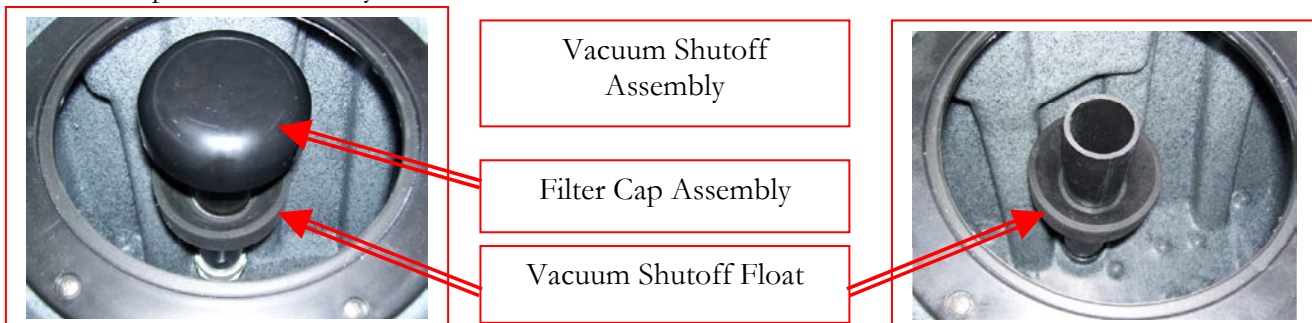

CLEAN THE HYDRO-FILTER II:

Build-up of debris in the filter screen of the Hydro-Filter II will reduce the vacuum air flow and may cause a significant decrease in water recovery. A torn filter screen will allow debris past the filter and into the recovery tank. This debris can clog the Waste Pump and the Vacuum Shutoff Assembly. **The Hydro-Filter II must be examined and cleaned regularly to keep the MX3-1200 functioning properly:**

- Grasp and turn the lid counterclockwise to open the Hydro-Filter II lid.
- Remove the filter screen. Examine the screen and clean or replace as needed.
- Rinse the body of the Hydro-Filter II with clean water.
- Examine the o-ring lid seal and replace as needed.
- Re-install the new or cleaned screen.
- Screw the lid back onto the body and turn clockwise to tighten.



RINSE OUT RECOVERY TANK:

Build-up of fine silt, sand and other debris in the recovery tank can damage the Drain Valve (and Waste Pump if so equipped). Hair and fibers in the recovery tank can clog the vacuum filter (and Pump-out filter if so equipped). Clean out the tank on a regular basis to extend the life of these components and to keep the tank and machine smelling better.

- Remove the recovery tank lid and open the drain valve.
- Place a bucket under the drain valve.
- Use a hose to rinse the dirt and debris out of the recovery tank.
- Close the drain valve and spray the tank with a deodorizer or disinfectant.
- Proceed to Waste Pump Cleaning and replace the recovery tank lid.
- Dispose of the dirty water and debris.



CLEAN WASTE PUMP-OUT PUMP:

Build-up of fine silt inside the Waste Pump can clog the pump even if the pump is not used, so this maintenance procedure should be performed regardless of whether the Waste Pump has been used.

- After cleaning out the recovery tank, remove the cap and connect the Pump-Out hose to the Waste Pump outlet fitting on the back of the machine; run the hose to a drain.
- Remove the waste pump filter screen by turning it counterclockwise. Remove the filter screen. Examine the screen and clean or replace as needed.
- Re-install the filter screen. Thread the filter loosely on to the nipple – Leave slightly loose to keep it easy to remove for future cleaning.
- Use a hose to fill the recovery tank approximately 1/2 full with clean water.
- With Cord #2 plugged in, turn the Waste Pump switch to the ON position.
- Let the pump run until it pumps the level down to the point below the pump intake filter.
- Unplug the cord and turn the Waste Pump switch OFF.
- Open the drain valve and drain out the remaining water.
- Close the drain valve, replace the recovery tank lid, and dispose of the dirty water and debris.



FLUSH SOLUTION TANK AND PUMP:

- Pour two or three gallons of clean water into the solution tank.
- With Cords #1 & #2 plugged in, connect a solution hose to the solution outlet female quick connect. The other end of the hose should have an open quick connect or no quick connect to allow full flow out of the hose. Direct the open end of the solution hose into the recovery tank vacuum barb.
- Turn one or both of the vacuums ON and turn the solution pump ON. Let the pump run until most of the water has been pumped out of the solution tank.

NOTICE

Do not let the pump run dry. Turn the pump OFF before the water gets to the bottom of the tank.

- Turn the vacuums OFF and disconnect the open flow solution hose.
- Place a bucket under the drain valve; open the drain valve to drain the water out of the recovery tank.
- Close the drain valve and dispose of the water.

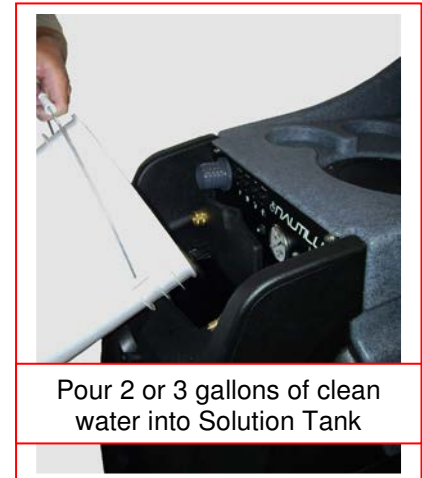

Pour 2 or 3 gallons of clean water into Solution Tank

If there is a heavy chemical build-up in the machine, hoses, or tools, a mild acid can be added to the rinse water in the previous procedure (REFER TO PHOTOS ON FOLLOWING PAGE.)

- After the pump has been primed, turn the solution pump switch OFF and turn the vacuums OFF.
- Remove the prime hose and connect the HP solution hose and tools.
- Turn the solution pump ON and direct the tool spray into a bucket. Let the pump run until most of the water has been pumped out of the solution tank.

NOTICE

Do not let the pump run dry. Turn the pump OFF before the water gets to the bottom of the tank.

FLUSH SOLUTION TANK AND PUMP: (continued from previous page)

- Disconnect the solution hose and tool.
- Use the 4' short section of vacuum hose to vacuum the remaining acid solution out of the solution tank.
- Pour two or three gallons of clean water into the solution tank.
- Connect a solution hose to the solution outlet female quick connect. The other end of the hose should have an open quick connect or no quick connect to allow full flow out of the hose.
- Direct the open end of the solution hose into the recovery tank vacuum barb.
- Turn one or both of the vacuums ON and turn the solution pump ON. Let the pump run until most of the water has been pumped out of the solution tank.

NOTICE

Do not let the pump run dry.

Turn the pump OFF before the water gets to the bottom of the tank.

- Turn the vacuums OFF and disconnect the open flow solution hose.
- Place a bucket under the drain valve and open the drain valve to drain the water out of the recovery tank.
- Close the drain valve and dispose of the water.

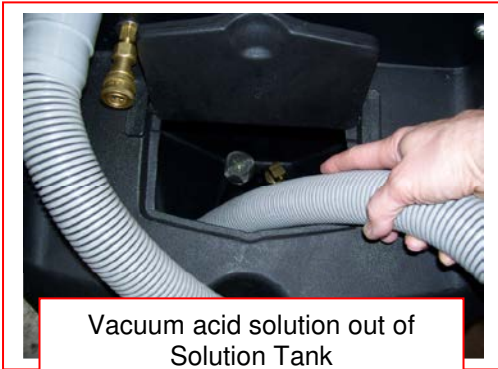

CLEAN PUMP INLET FILTER

A restricted Pump Inlet Filter can prevent the solution pump from providing adequate pressure for cleaning. A restriction or air leak on the pump inlet hose can also damage the solution pump check valves and plunger seals.

- To examine the filter, open the solution tank lid on the front of the machine. The filter is in the bottom of the solution tank.
- Grasp the filter cap and unscrew the filter from the brass nipple by turning counter-clockwise. Clean or replace the filter as needed (PP14-806504).



WARNING Before proceeding with this procedure, drain the solution tank & recovery tank.

Make sure both power cords are disconnected.

- To examine the pump inlet hose, release the latches on the front/bottom of the machine and tilt the tanks off of the base assembly.
- Examine the hose for kinks, clogs or holes and repair or replace the hose as needed.
(Replacement Hose: NM5086 – sold per foot)
- Tilt the tanks back onto the base and secure the latches.

SOLUTION FILTER
PP14-806504



FLUSH CHEMICAL SYSTEM:

Chemical build-up in the chemical system can prevent the system from drawing chemical.

- Rinse the chemical system with fresh water (For heavy chemical build-up, a mild acid can be added to the rinse water.)
- Remove the chemical feed hose from the solution tank and place the end of the hose in a bucket of fresh water or mild acid solution.
- Connect the Auto-Fill Water Supply Hose to the water inlet (male quick connect) on the front of the machine.
- Connect the other end of the hose to a water faucet and turn on the water. Let the water flow into the tank until you are sure the rinse solution has been drawn through the proportioner and mixed with the incoming water. The metering tip can be removed from the proportioner to speed up the process.
- Once the rinse solution has been drawn through the proportioner, turn off the water faucet and disconnect the Auto-Fill Water Supply Hose.
- Plug in Cord #1, connect the short 4' vacuum hose to the vacuum barb, turn on one or both vacuums, and use the short vacuum hose to remove the water from the solution tank.
- When the solution tank has been emptied, turn off the vacuums and unplug the power cord.
- Place a bucket under the drain valve and open the drain valve to drain the water from the recovery tank.
- Close the drain valve and dispose of the water.



Place Chemical Feed Hose into Rinse Solution

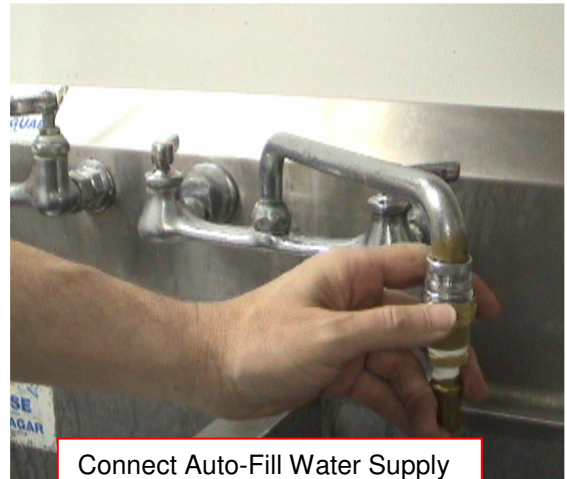

Connect Auto-Fill Water Supply Hose to machine and faucet



Vacuum water out of Solution Tank



Drain water from Recovery Tank

LUBRICATE PRESSURE REGULATOR O-RINGS:

To maintain consistent adequate pressure delivery to the cleaning tool, the o-rings on the stem of the MX3-1200 pressure regulator must be lubricated regularly.

1. Remove the black knob from the regulator.
2. Unscrew the brass knob assembly from the piston retainer.
3. Remove the spring plate and spring from the piston retainer.
4. Unscrew the piston retainer from the regulator body.
5. Hold the hex head of the spindle with a wrench while using a screw driver to turn the piston screw and separate the spindle head & piston screw so they can be removed from the stem retainer.
6. Use a synthetic grease with Teflon such as Ultra-Slick or Super-Lube to lubricate the o-rings on the piston and spindle assembly.
7. Re-install the piston and spindle assembly into the retainer and tighten.
8. Apply thread sealant to the threads of the stem retainer and screw the retainer back into the regulator body and tighten.
9. Replace spring and spring plate back into brass knob assembly and re-install the brass knob.
10. Push black knob back onto the brass knob.

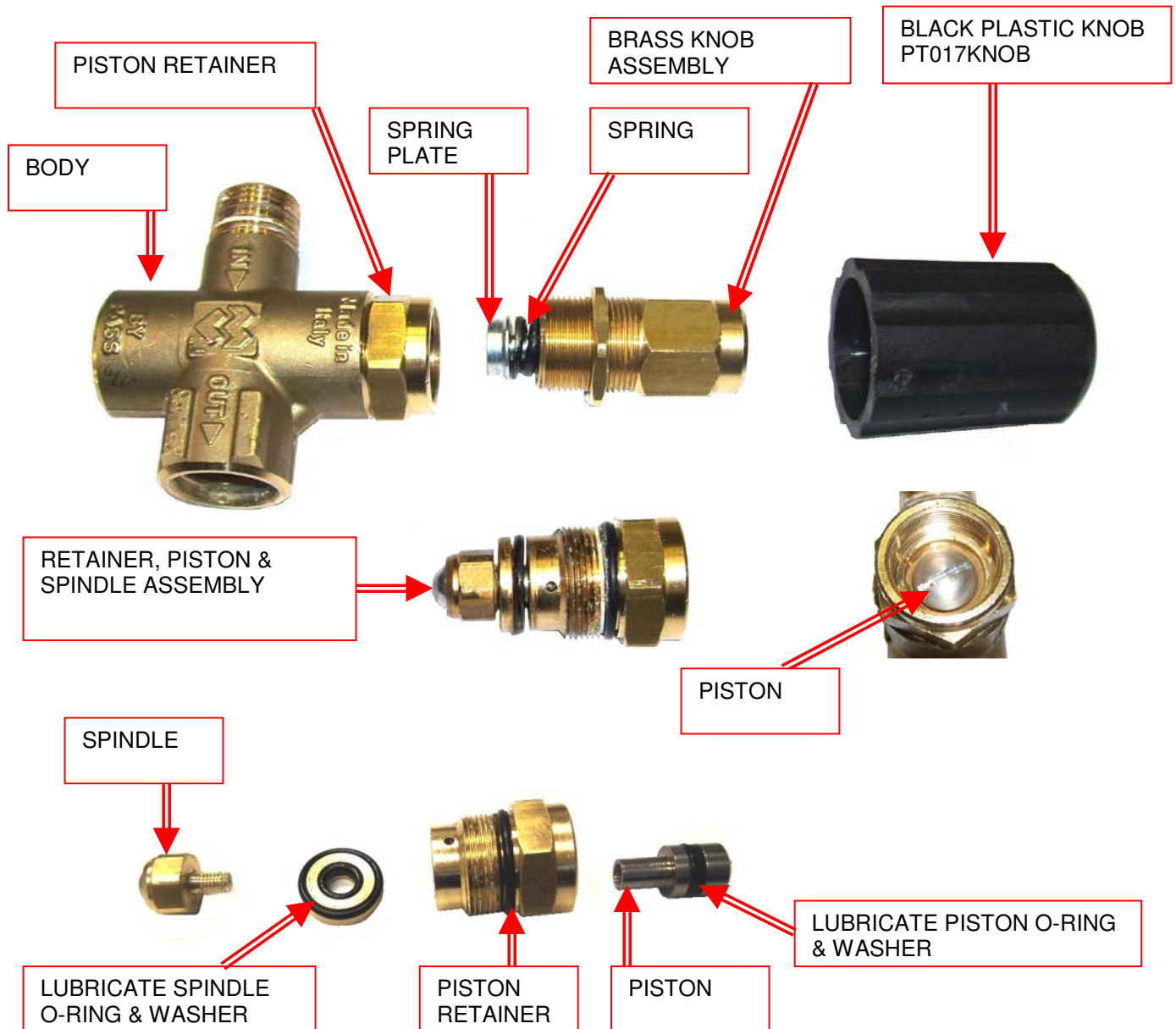

CLEAN RECOVERY TANK DRAIN

Debris and sand accumulation in the drain valve can damage the valve or prevent it from closing completely. This will result in dirty water leaking from the valve. Use of the Hydro-Filter and regular cleaning of the recovery tank will help prevent this, but occasionally the drain valve will require cleaning or replacement.

⚠ WARNING

Unplug both cords and drain the recovery tank before attempting to service the drain valve.

- Unscrew the nuts and remove the four bolts holding the valve assembly to the flange attached to the recovery tank. Unless the flange is damaged, it does not have to be removed from the tank, even when replacing the drain valve.
- Separate the valve body, outlet adapter and gaskets from the flange.



Remove four bolts holding valve assembly to flange fitting

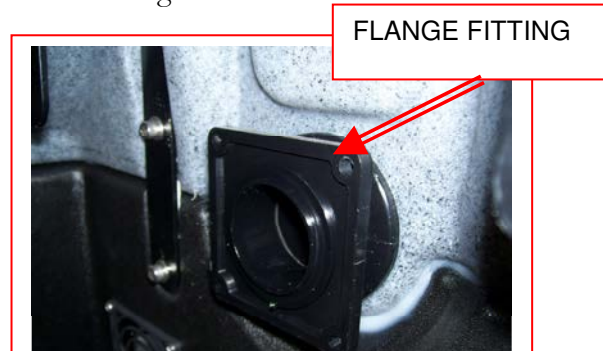

FLANGE FITTING

Unless damaged or leaking between tank and flange, the flange fitting does not have to be removed



DRAIN VALVE – PE11

VALVE BODY

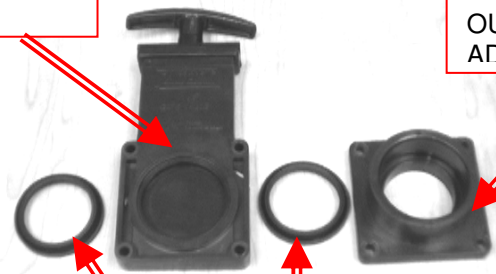

OUTLET ADAPTER

GASKET – NM3019

- Examine the valve body for wear. Check the valve slide for deep scratches. Deep scratches will allow water to flow past gaskets and leak from valve. Replace valve if needed.
- Examine the gaskets and replace if cut, torn or deformed.
- Raised, rounded side of gasket goes toward valve slide. Larger flat sides seat on ring on flange and outlet adapter. Sand and debris will collect in the bottom of the valve body and prevent the slide from going down and seating properly.
- Clean debris out as needed so slide can move to bottom.
- Rinse valve body and reassemble valve body, gaskets and outlet adapter, and place assembly back onto flange fitting.
- Replace four bolts and tighten evenly to secure assembly to flange. Do not over-tighten bolts.



Clean debris from slot in bottom of valve body. Valve slide must be able to slide to bottom.

Storage Prep and Freeze Protection Procedures:

Your Nautilus MX3-1200 must be protected from freezing. Freezing can cause serious damage to the pump, pump-out, auto-fill float valve, and any other component containing water. If the MX3-1200 is transported or stored in freezing temperatures, the following procedures should be performed.

ALSO, if the MX3-1200 is stored for an extended period of time, the following procedure should be performed to prevent the pump seals from drying out.

1. In a separate container mix 1/2 gallon of water with 1/2 gallon of automotive radiator Ethylene Glycol anti-freeze. (Propylene glycol can be used as a non-toxic alternative anti-freeze.). Mix well and pour into the solution tank.
2. Connect the solution hose to the solution outlet (female quick connect. Connect the HP solution hose to the solution outlet (female quick connect.) Connect the opposite end of the HP solution hose to the Auto-Fill inlet (male quick connect.) Leave the chemical feed hose in the solution tank and ensure the check valve filter is submerged in the anti-freeze solution. To speed the process the metering tip can be removed. Turn the pressure regulator knob counter-clockwise to lower the pressure to 100psi or lower.

NOTICE

Applying high pressure (over 100psi) to the Auto-Fill system will cause damage to the Float valve and chemical proportioning mechanism.

3. Turn the solution pump switch to the ON position and perform the pump priming procedure. Hold the priming valve open for a few extra seconds to be sure the anti-freeze has passed through the priming valve. When the pump is primed, allow the anti-freeze to circulate for 5-10 minutes. Mix and add more anti-freeze solution as needed. Make sure end of chemical feed hose stays submerged in the anti-freeze solution. This will assure that the anti-freeze will be drawn into the proportioning valve.
4. Connect any cleaning tools that will be stored with the MX3-1200. Direct tool spray back into the solution tank or into a bucket. Repeat for all tools to be protected.
5. Turn the solution pump switch to the OFF position.
6. Use the 4' short section of vacuum hose to vacuum the remaining anti-freeze solution out of the solution tank and bucket.
7. Remove the cap from the waste-pump out outlet fitting on the back of the machine. Connect a hose to a drain or hold a bucket up to the fitting to catch the pump-out flow.
8. Remove the lid from the recovery tank. Turn the Waste Pump switch to the ON position to engage the pump-out. Turn off the Waste Pump Switch as soon as you see anti-freeze flowing from the outlet fitting or hose.
9. Drain the remaining anti-freeze solution from the recovery tank and the machine is ready for storage.

RETURNING THE MX3-1200 TO SERVICE AFTER STORAGE OR FREEZE PROTECTION:

To return the MX3-1200 to service, the anti-freeze must be flushed from the machine. Flush the anti-freeze out of the machine by repeating the procedures above using fresh water in place of anti-freeze.

Parts

Replacement parts available for repair of your MX3-1200.

MX3-1200 PUMP – AP48 PARTS ASSEMBLY

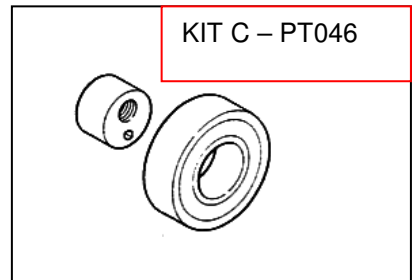
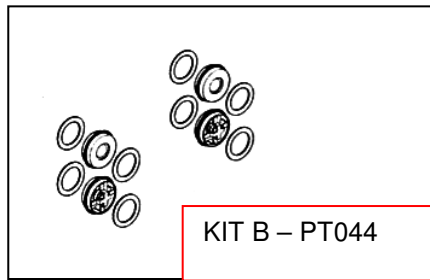
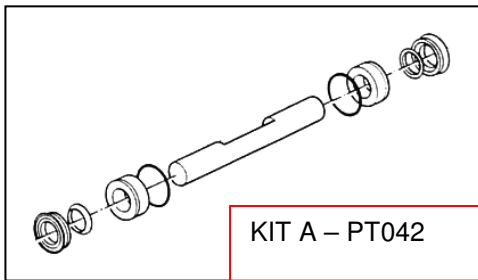
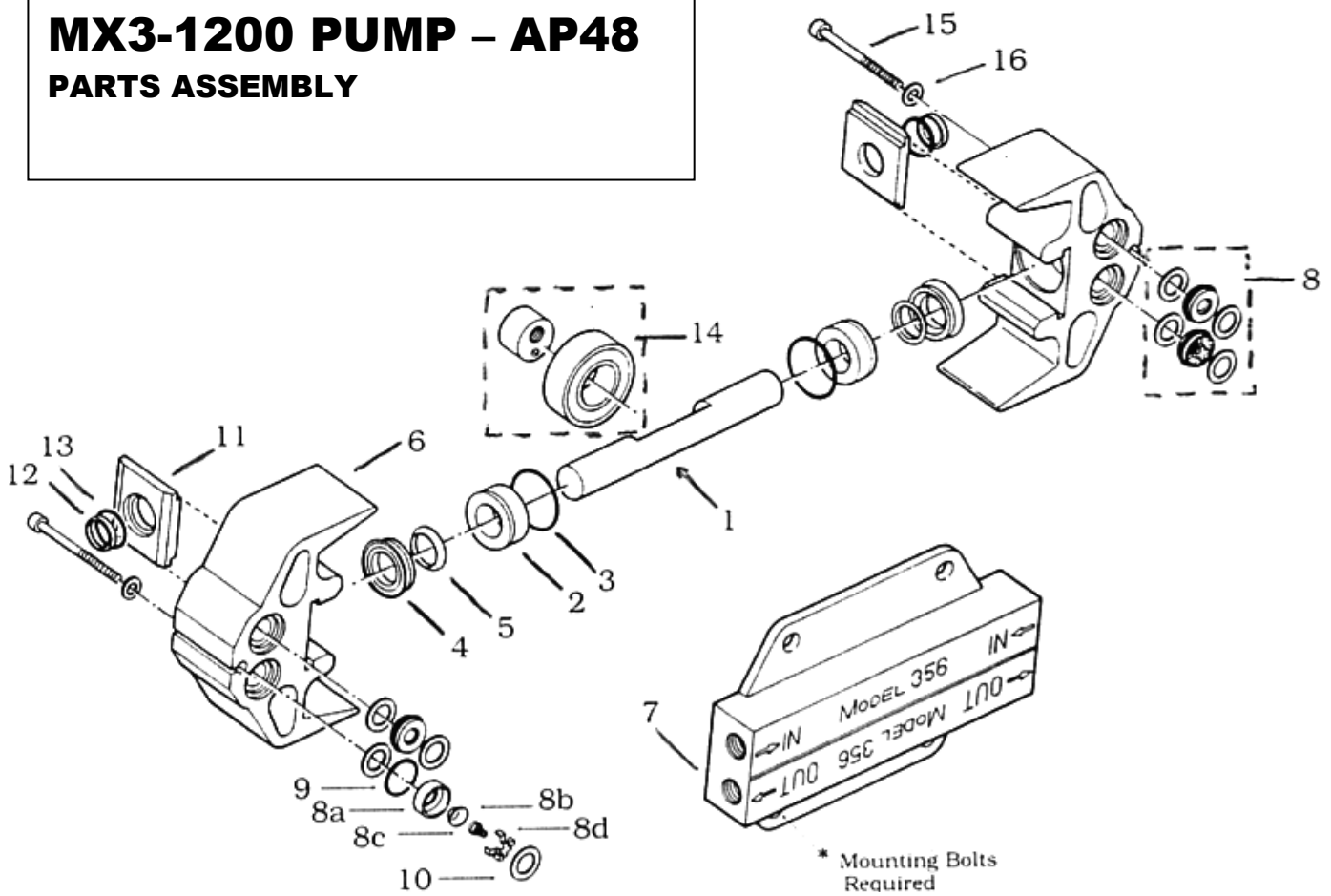

PUMPTEC #356 PUMP – AP48

ITEM	DESCRIPTION	QTY	PART NUMBER
1	PLUNGER	1	0311-0006-0002
2	PLUNGER GUIDE	2	0311-0009
3	O-RING FOR PLUNGER GUIDE	2	C0100-1124
4	U-CUP	2	C0220-1075
5	U-CUP BACKING RING	2	0311-0011
6	PUMP HEAD	2	0356-0002-0001
7	PUMP MANIFOLD	1	0356-0004-0001
8	VALVE ASSEMBLY	4	0205-0012
8A	VALVE SEAT (Part of #8 - Valve Assembly)	4	0205-0017
8B	VALVE POPPET (Part of #8 - Valve Assembly)	4	0205-0013
8C	VALVE SPRING (Part of #8 - Valve Assembly)	4	C1220-0001
8D	SPRING RETAINER (Part of #8 Valve Assembly)	4	0205-0014
9	O-RING FOR VALVE	4	C0100-1116
10	PLASTIC SPACER RING	8	0205-0016
11	GUIDE & VACUUM SEAL RETAINER	2	0311-0012
12	VACUUM SEAL	2	0311-0010
13	O-RING FOR VACUUM SEAL	2	C0100-1117
14	BEARING ASSEMBLY	1	0300-1000-0001
	ECCENTRIC INSERT (Part of #14 – Bearing Assembly)	1	0300-0001-0XXX
	BEARING 6205 (Part of #14 – Bearing Assembly)	1	C3000-0003
15	SOCKET HEAD CAP SCREW	2	C100-0504
16	WASHER AN TYPE	2	C1500-0004
KIT A	PLUNGER & SEALS – Includes 1, 2, 3, 4, 5, 12 & 13	1	PT042
KIT B	VALVES & O-RINGS – Includes 8, 9 & 10	1	PT044
KIT C	BEARING ASSEMBLY (#14)	1	PT046
	PUMP COMPLETE - WITHOUT MOTOR	1	PT058
	MOTOR	1	PT059
	MOUNTING BOLTS 3/8-16 X 2-3/4"	4	

AUTO-FILL ASSEMBLY – M013

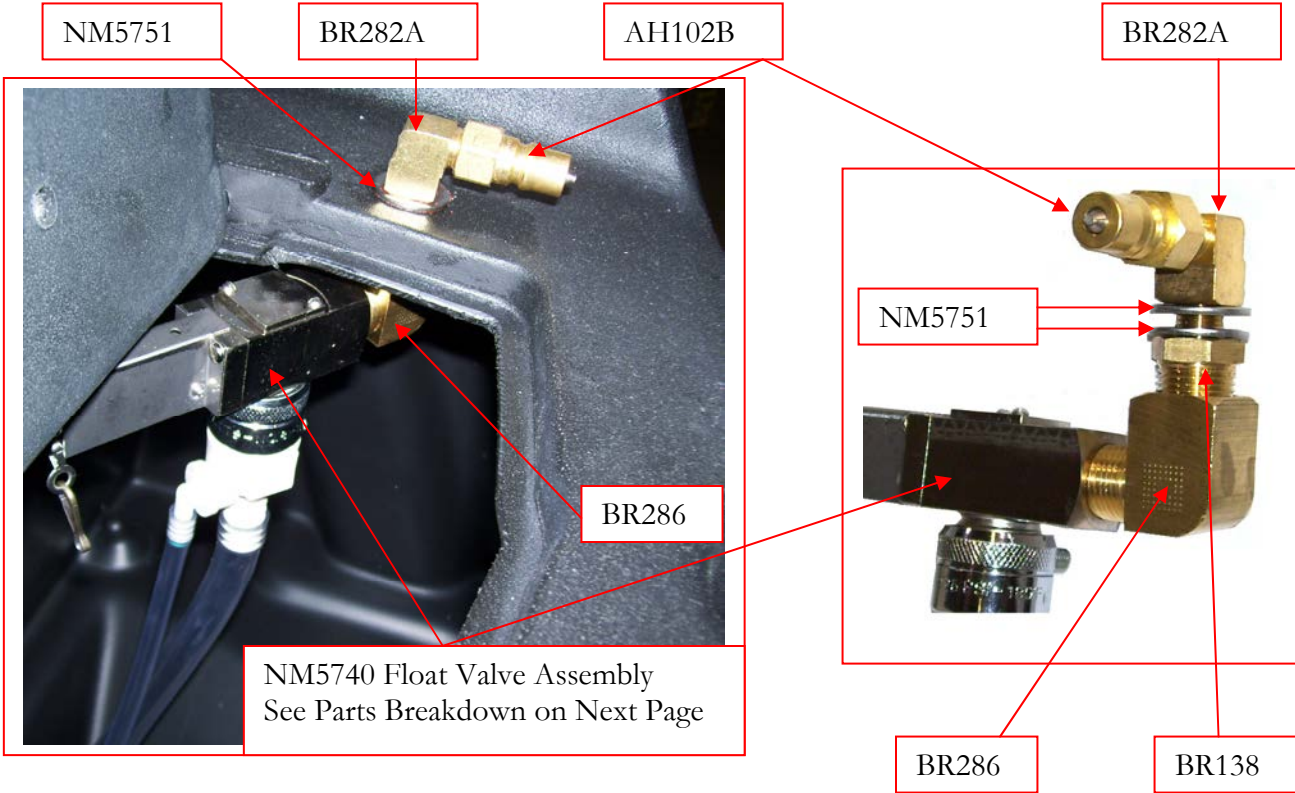

NM5740 AUTO-FILL FLOAT VALVE ASSEMBLY

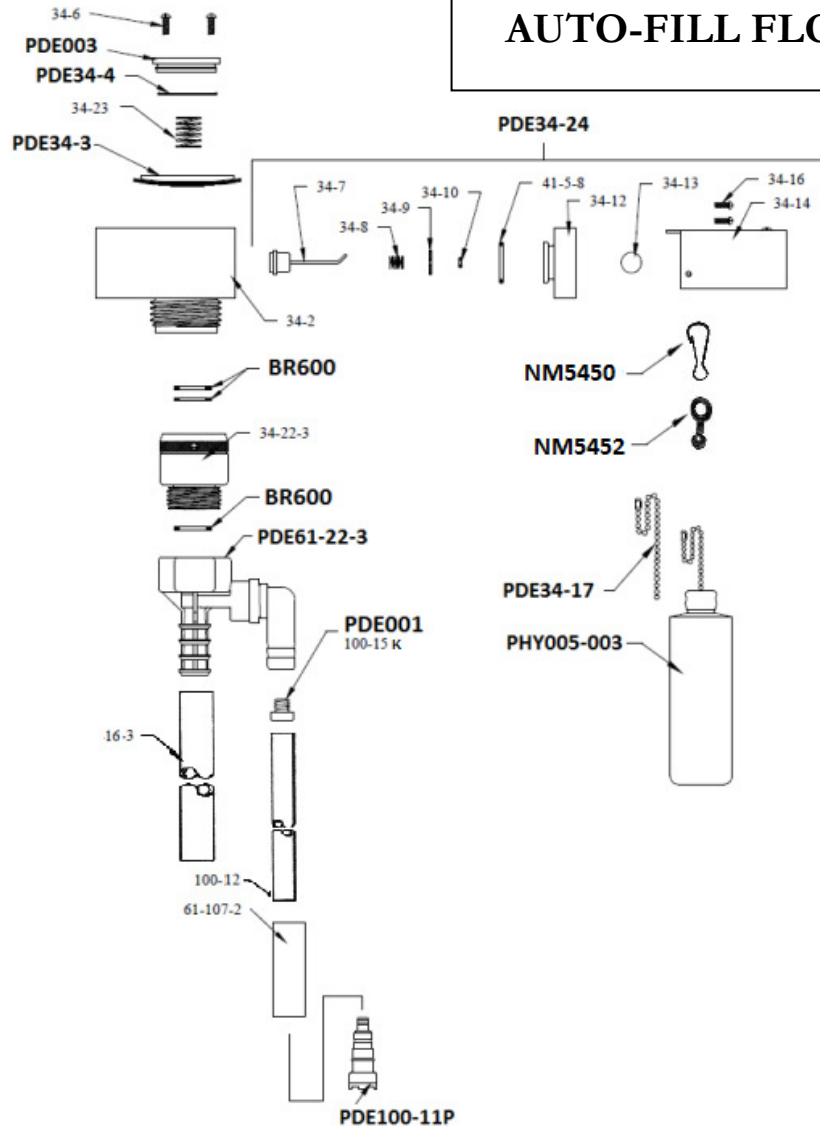

PART NO.	DESCRIPTION	PART NO.	DESCRIPTION
16-3	3' DISCHARGE TUBING	PHY005-003	FLOAT ASSEMBLY
34-1	INLET HOSE ADAPTER	PDE34-17	CHAIN WITH CONNECTOR
34-2	BODY ASSEMBLY	PDE61-22-3	PROPORTIONER ASSY
PDE34-3	DIAPHRAGM ASSEMBLY	61-107-2	CERAMIC WEIGHT
PDE34-4	VALVE COVER O-RING	NM5450	SNAP CLIP
PDE003	VALVE COVER	NM5452	CONNECTOR
34-6	VALVE COVER SCREWS (2)	BR600	RUBBER WASHER
34-7	PILOT VALVE DISC AND STEM ASSEMBLY	PDE001	METERING TIP KIT 14 TIPS
34-8	PILOT VALVE SPRING	100-15	METERING TIP SPECIFY SIZE
34-9	PILOT VALVE PLATE	100-12	8' PLASTIC SUPPLY TUBING 1/4" ID
34-10	PILOT VALVE STEM O-RING	PDE100-11P	FOOT VALVE
34-12	PILOT VALVE COVER		
34-13	STEM NUT WITH SET SCREW	AH102B	QUICK CONNECT 1/4" MALE
34-14	LEVER ASSEMBLY	BR282A	ELBOW 90DEG 1/4" STREET LONG PROFILE
34-16	LEVER ASSEMBLY SCREWS (2)	NM5751	WASHER 1/4" FLAT SS (2)
34-22-3	BACKFLOW PREVENTER	BR138	NIPPLE 1/2" X 1/4" HEX
34-23	CLOSING SPRING	BR286	ELBOW 90 DEG 1/2" STREET
PDE34-24	PILOT VALVE ASSEMBLY		
41-5-8	PILOT VALVE COVER O-RING	M013	NAUTILUS AUTO FILL KIT - COMPLETE

PT017

HP UNLOADER

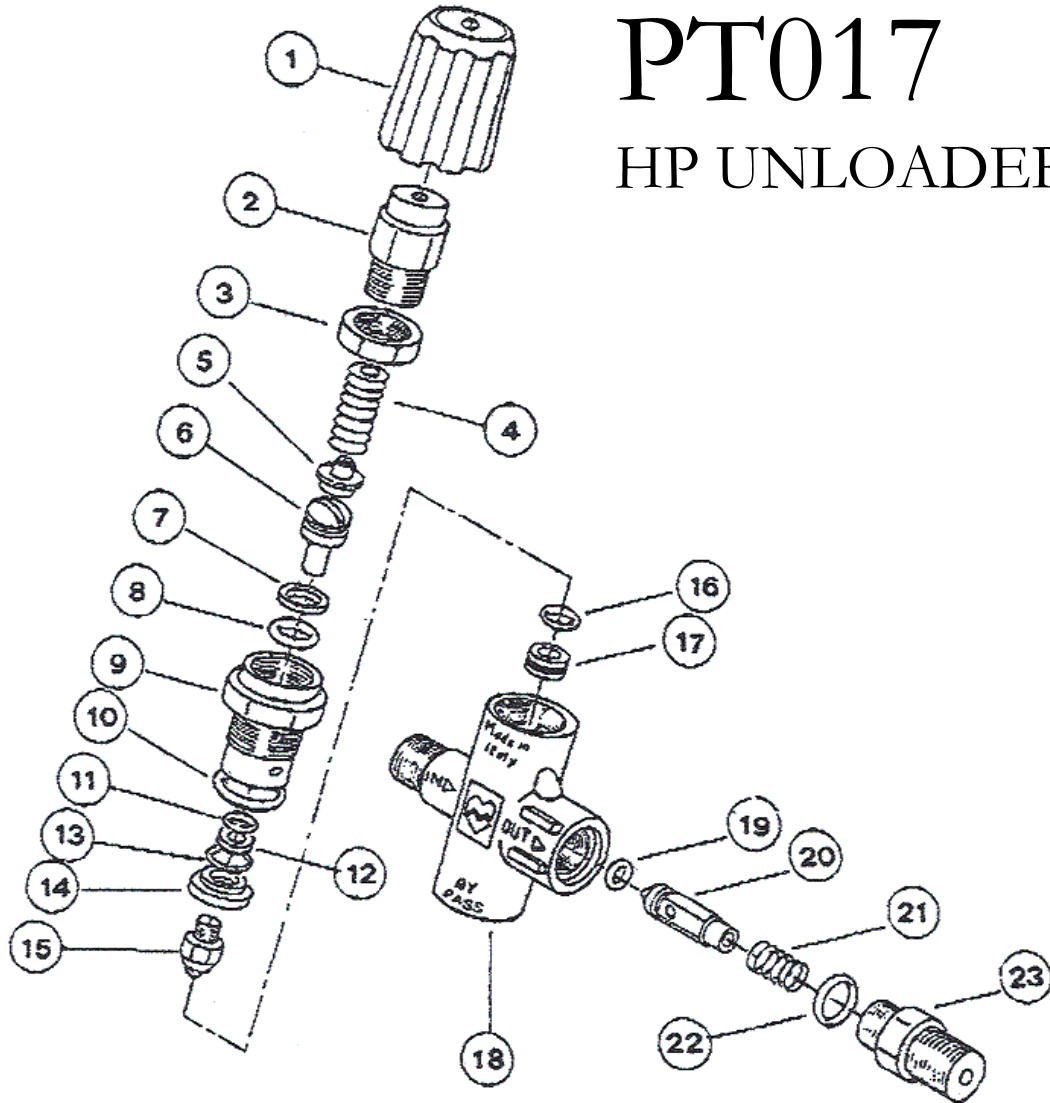

ITEM	DESCRIPTION	ITEM	DESCRIPTION	ITEM	DESCRIPTION
	HP UNLOADER PT017	8	PISTON O-RING - LARGE	16	SEAT O-RING
1	BLACK PLASTIC KNOB PT017KNOB	9	PISTON RETAINER	17	SEAT
2	BRASS KNOB	10	PISTON RETAINER O-RING	18	BRASS BODY
3	LOCKING NUT	11	PISTON O-RING - SMALL	19	POPPET O-RING
4	SPRING	12	PISTON WASHER - SMALL	20	POPPET
5	SPRING PLATE	13	SPINDLE O-RING	21	POPPET SPRING
6	PISTON	14	SPINDLE SPACER	22	OUTLET RETAINER O-RING
7	PISTON WASHER - LARGE	15	SPINDLE	23	OUTLET RETAINER
					REPAIR KIT - PT017KIT
					INCLUDES: PARTS 6-15

Pump-Out Pump

AP37

PARTS ASSEMBLY

AP37 PARTS LIST

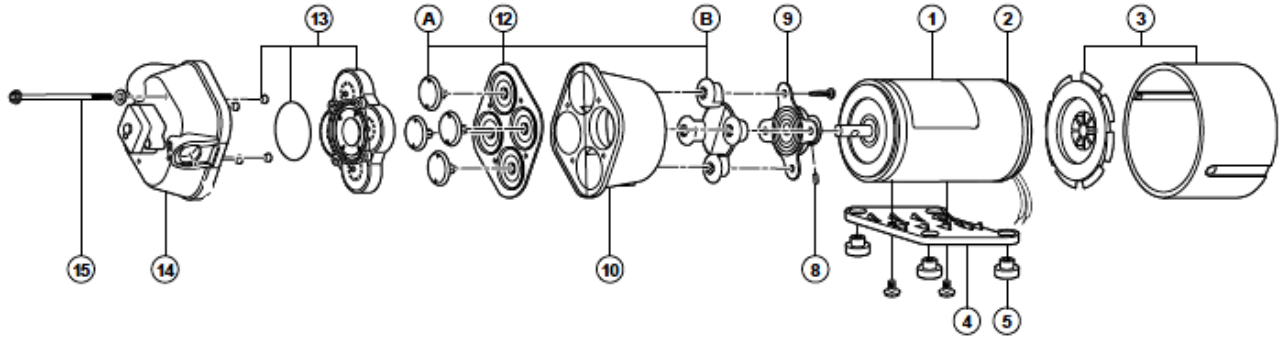

KEY PART NO.	DESCRIPTION	QTY	KEY PART NO.	DESCRIPTION	QTY
1	02009 -027A 15V AC Mtr	1	13	20407-020 Viton® Check Valve Kit w/"O" Ring & Ferrules	1
2	20115-113 Brush Endbell/Rect. Assy. (AC) w/BRG	1	14	20404-017 Upper Housing Assy Kit V/G SW45	1
3	20132-005 Fan/Shroud Kit	1	15	20405-000 Pump Screw Kit w/Washer & Ferrules	1
4	11028-101 Plastic Baseplate Assy. with Grommet & Screws	1	20381-010	3/4" Port Kit EPOM 90 DEG ELBOW	2
5	20132-000 Grommet Kit	Set of 4			
8	20552-000 Cam/Bearing Set Screw	1			
9	Cam/Bearing Kit w/Set Screw				
	20400-003	1			
10	20401-000 Bearing Cover P.P.	1			
12	20403-040 Diaphragm Kit w/Pistons & Screws Santoprene®	1			

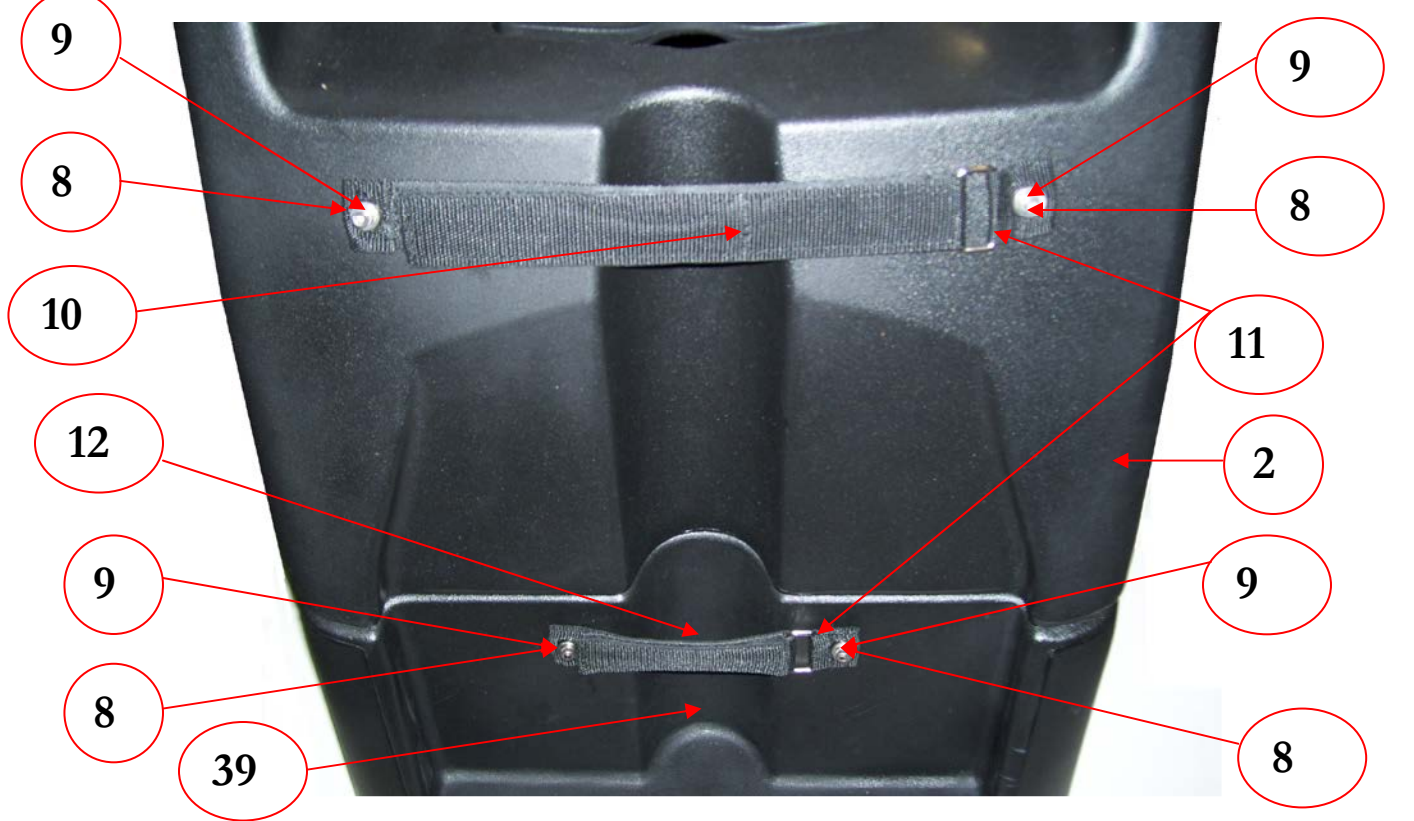
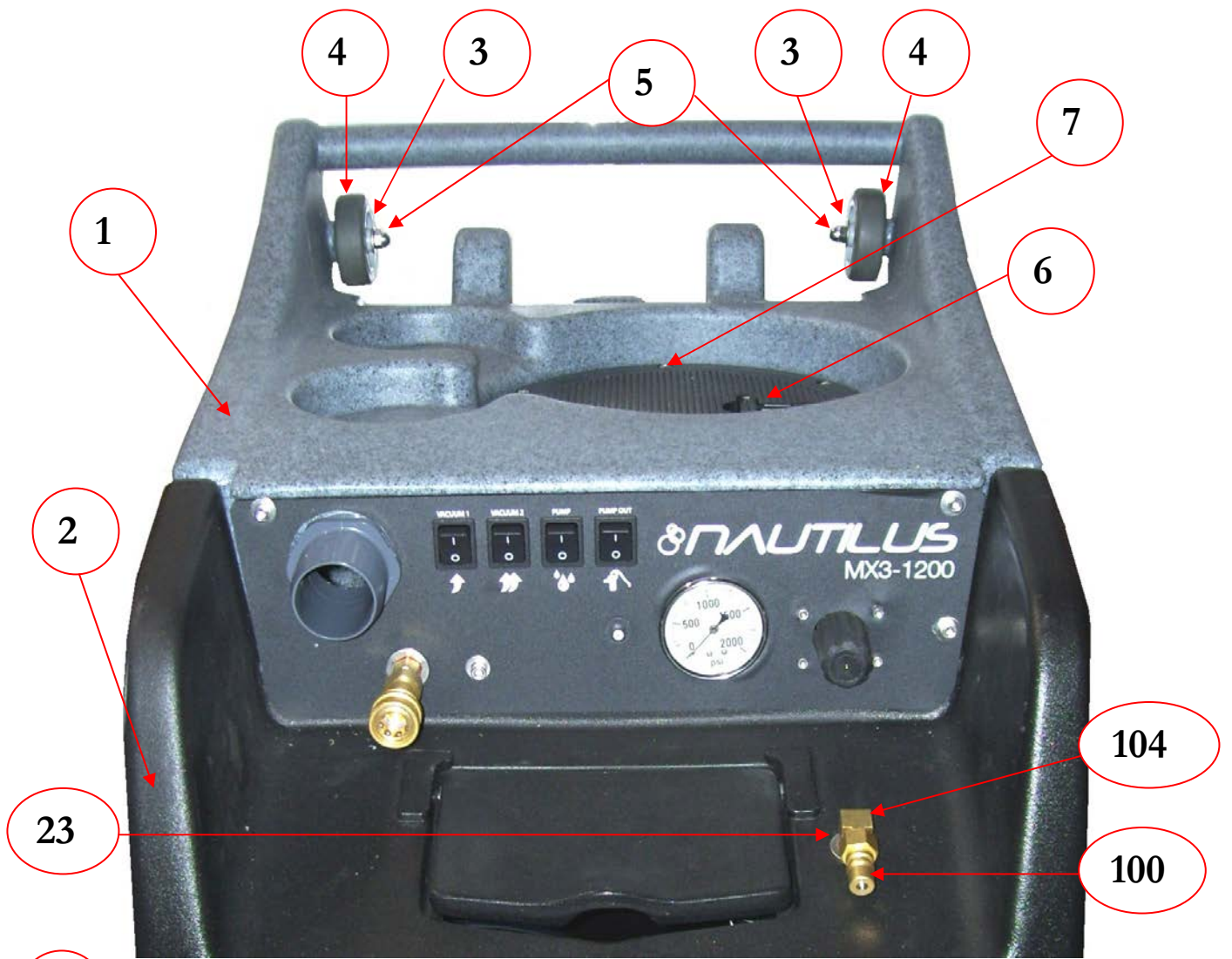

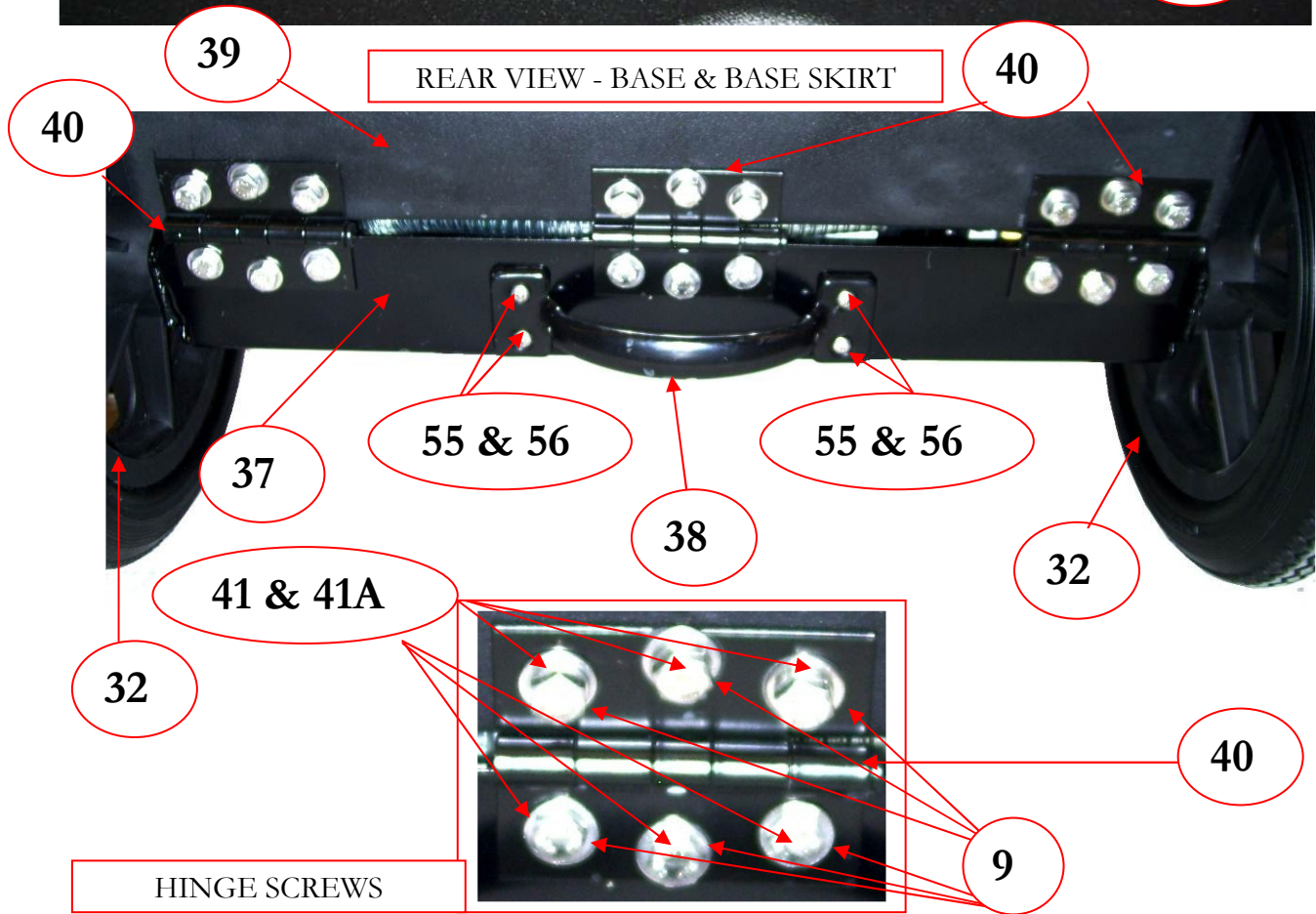
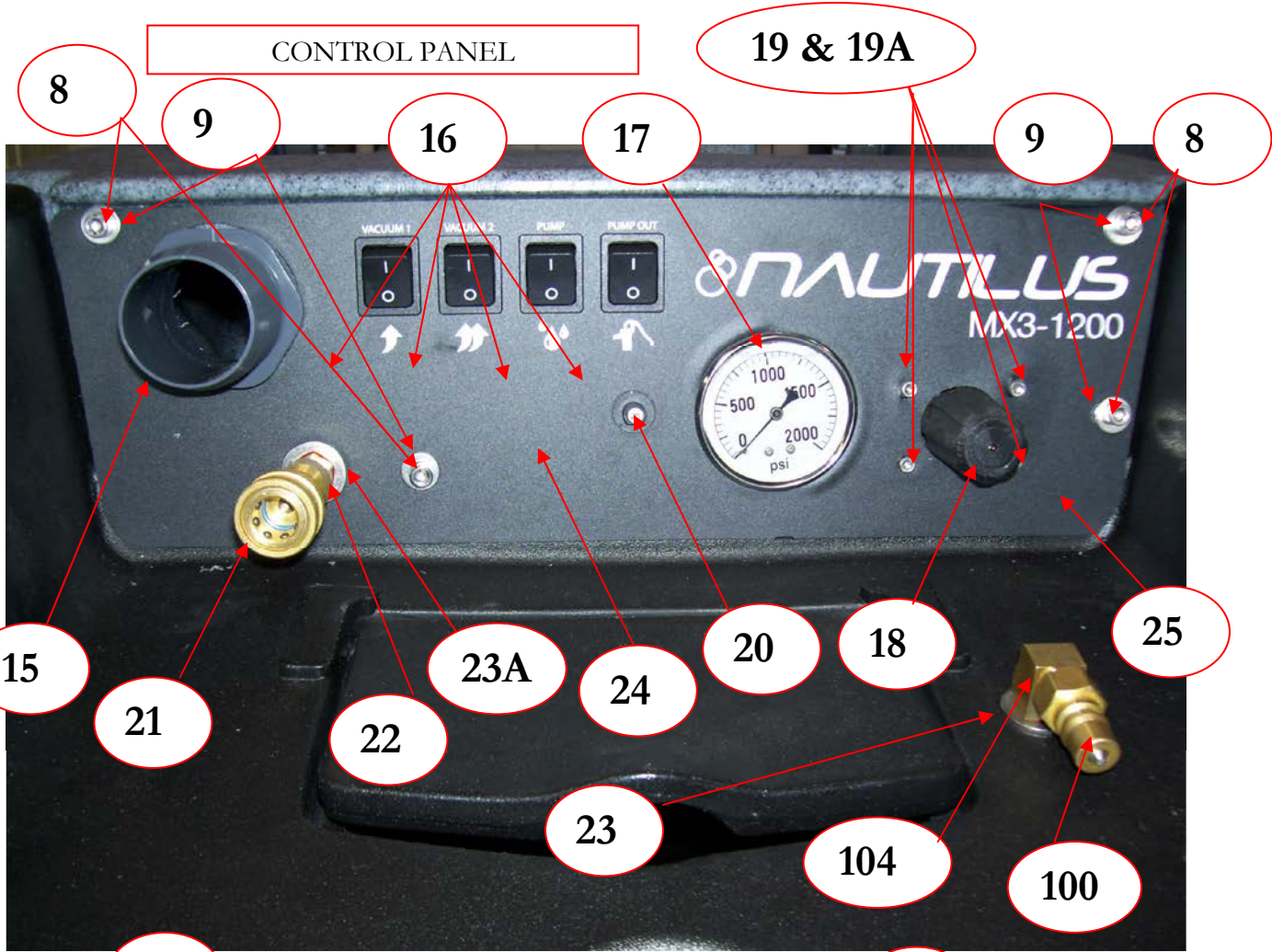

REAR VIEW – BASE, BASE SKIRT & RECOVERY TANK

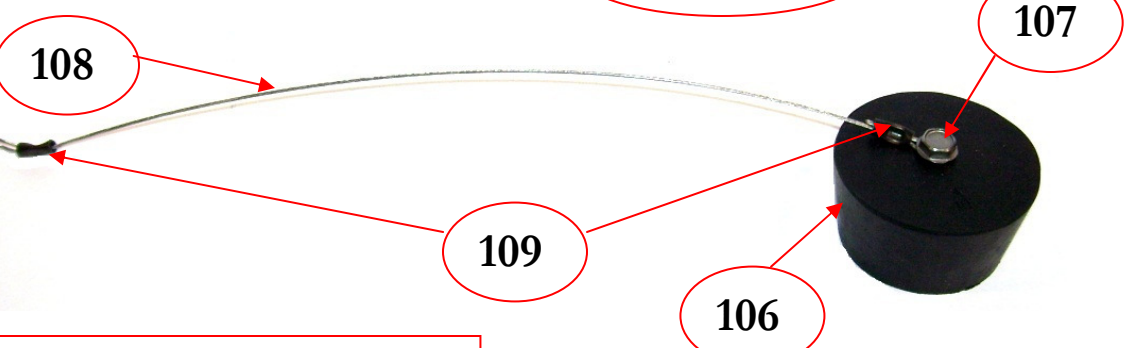
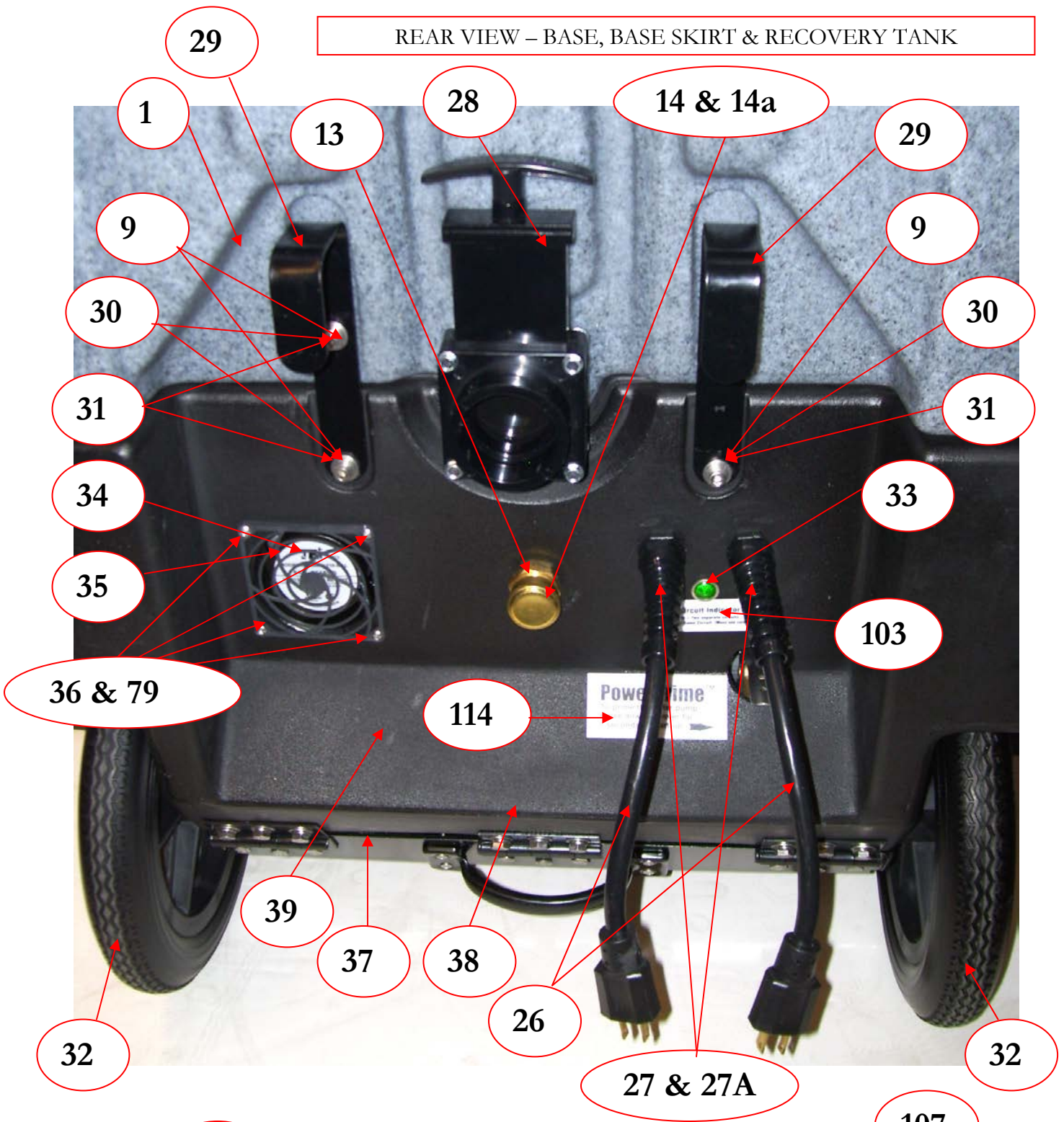

VACUUM PLUG ASSEMBLY

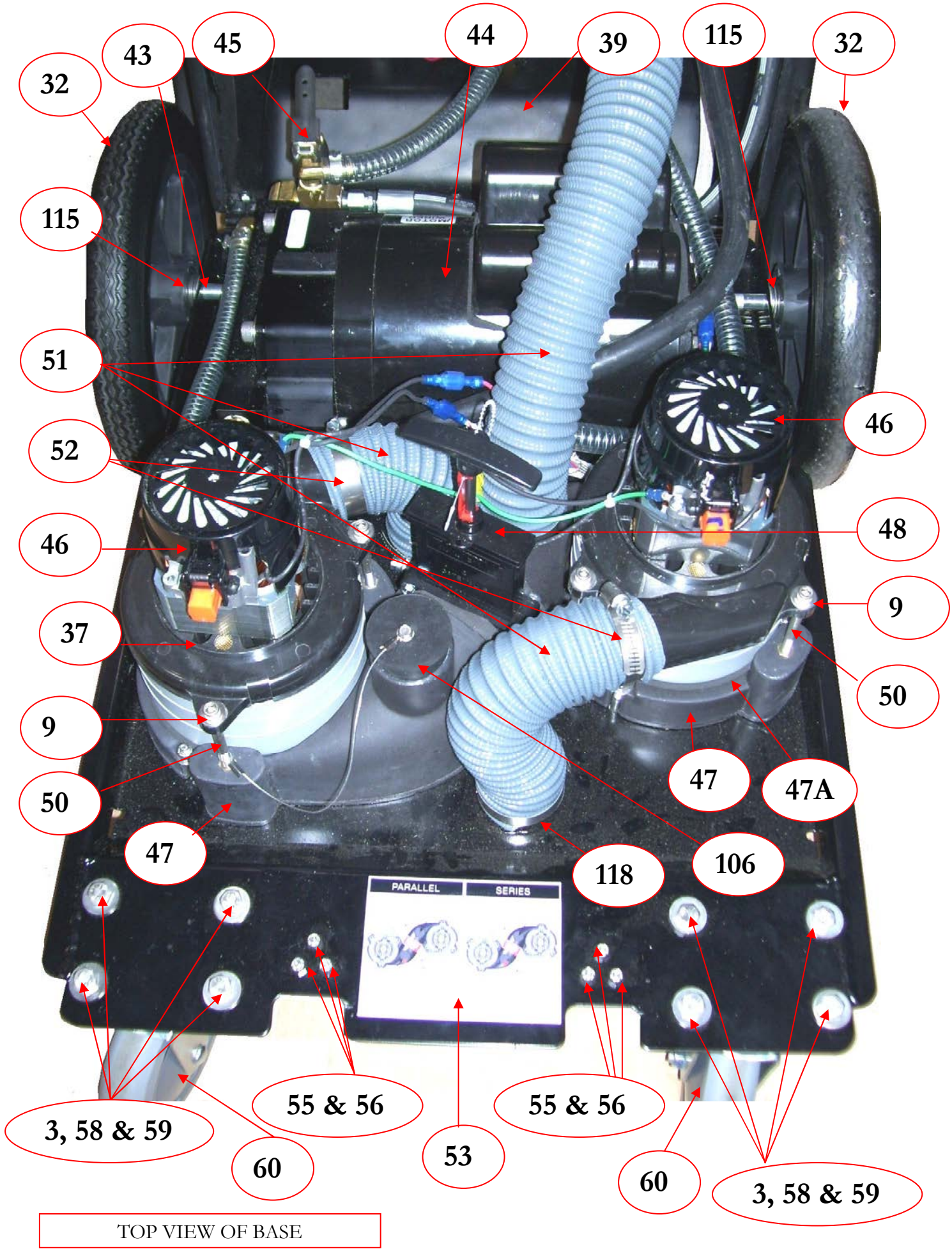

VACUUM MOUNTS & CONNECTIONS

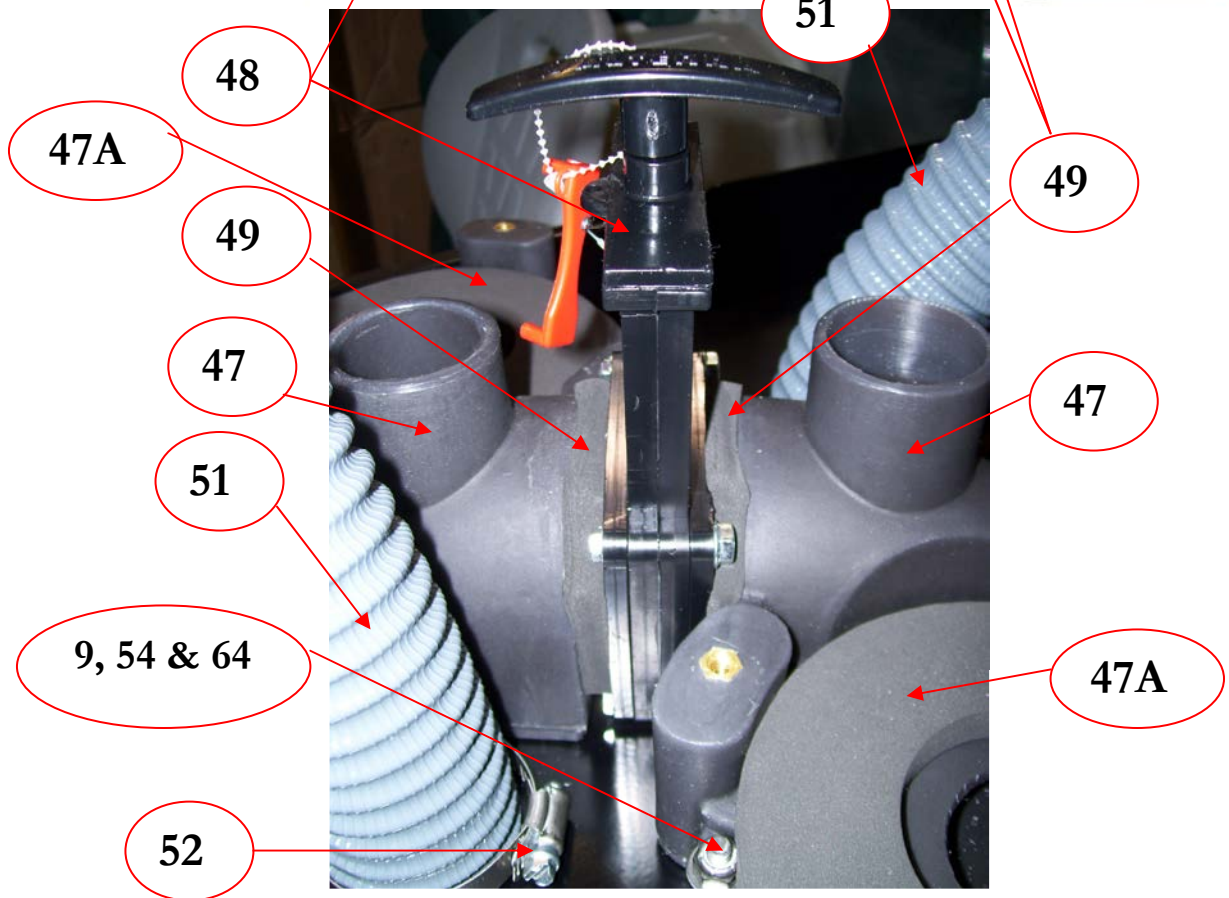
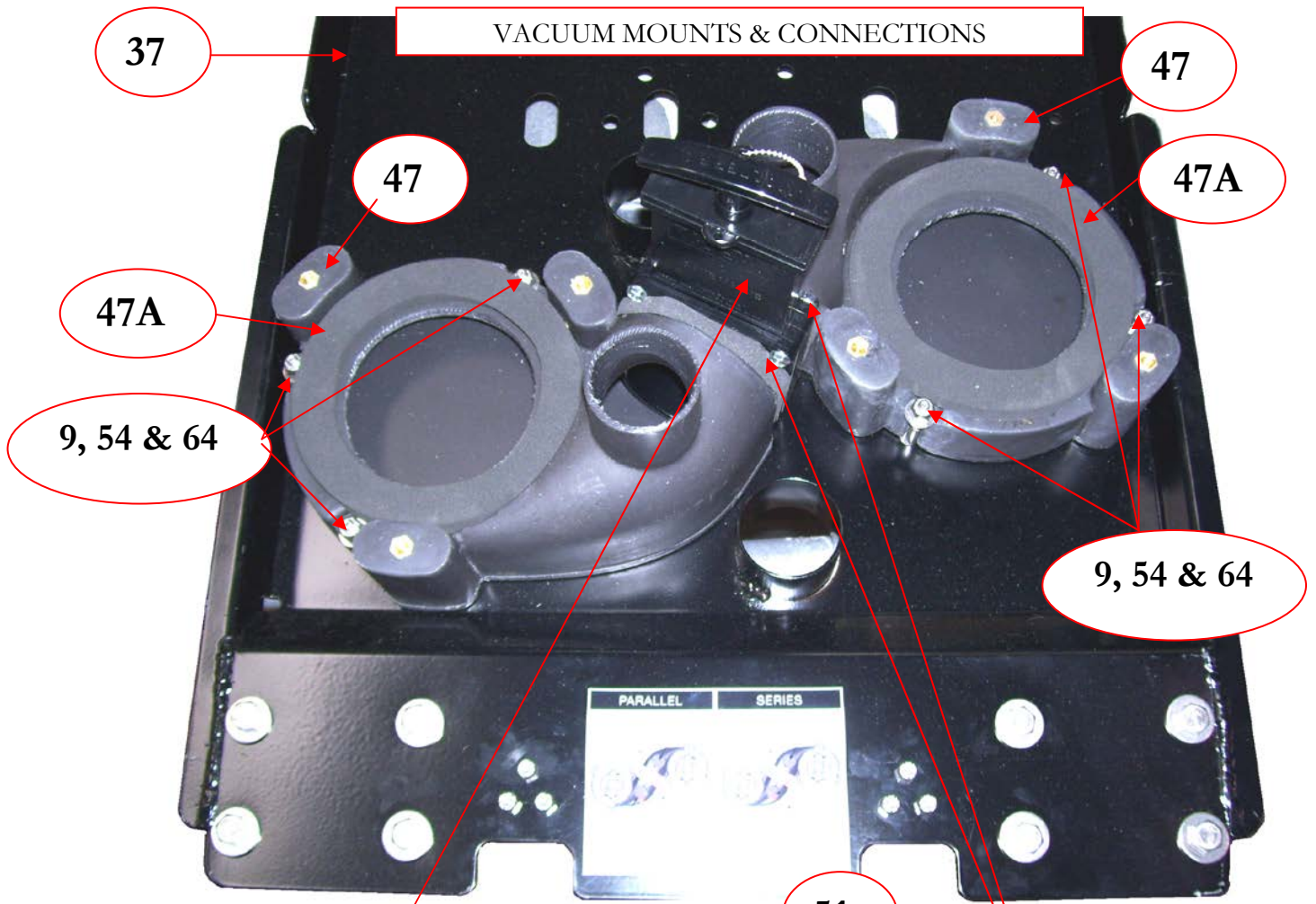

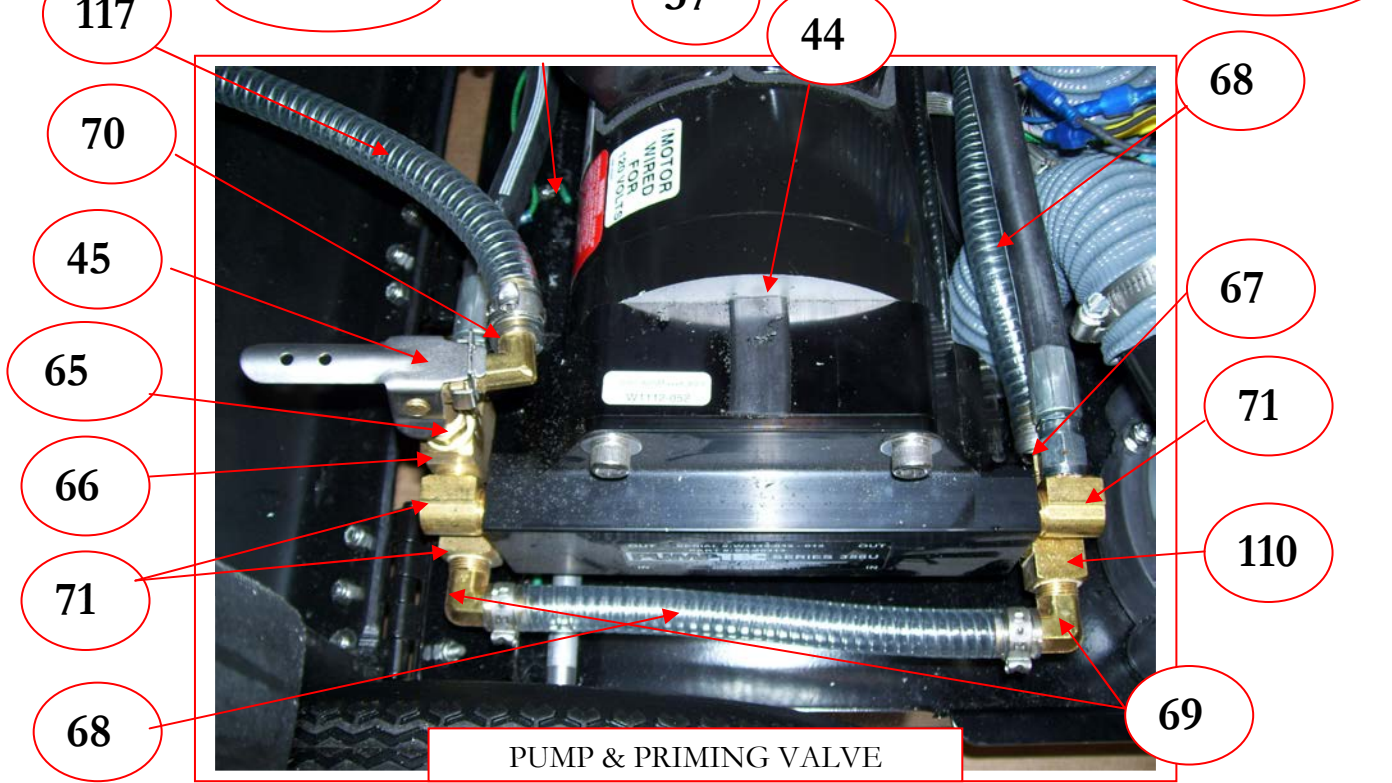
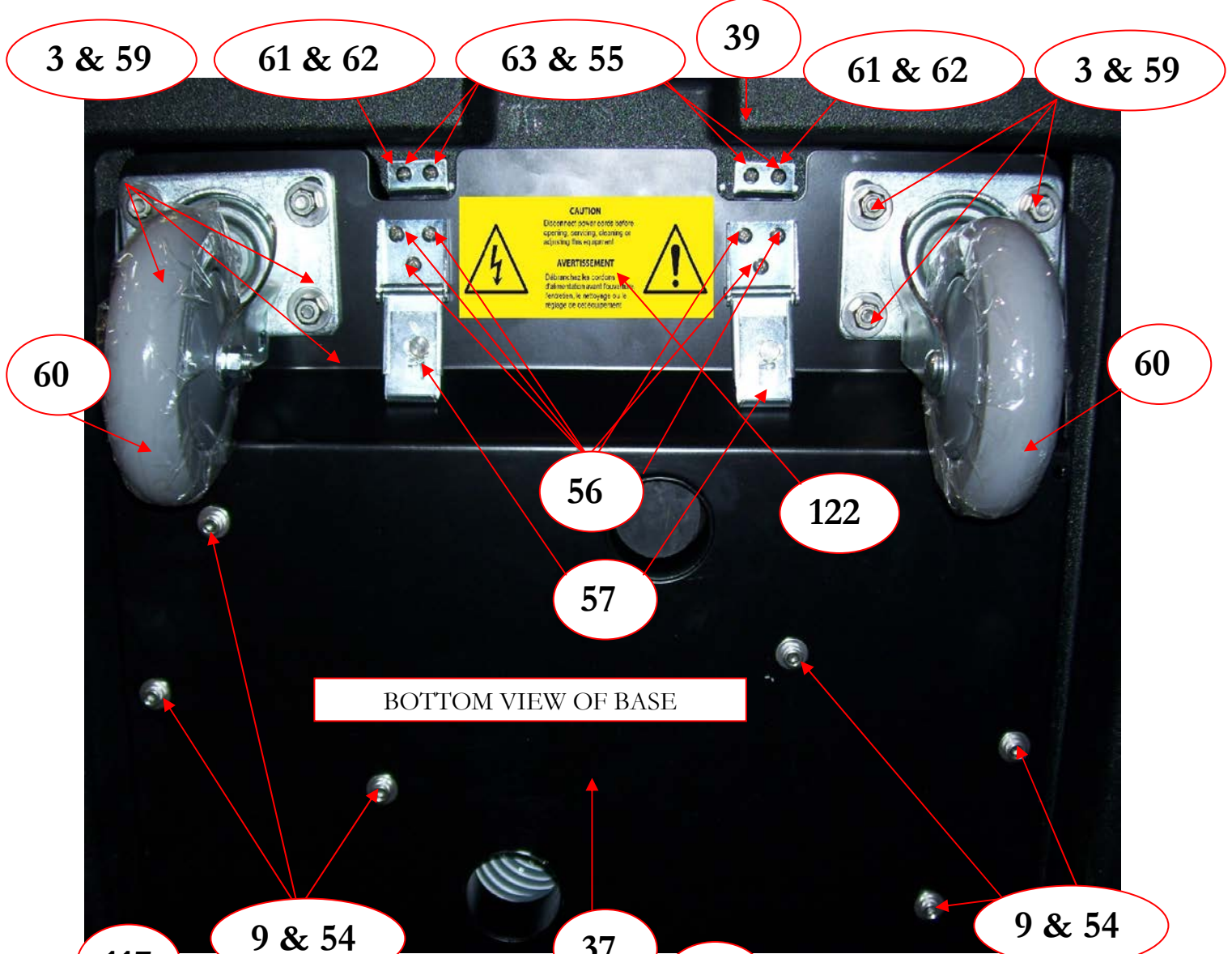

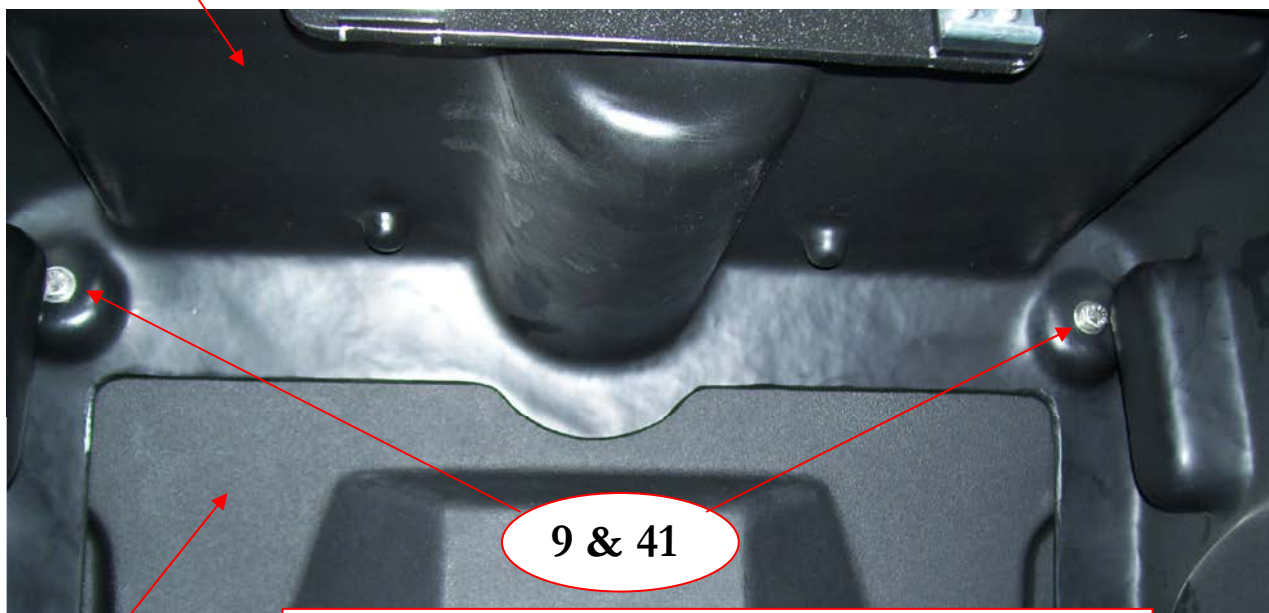
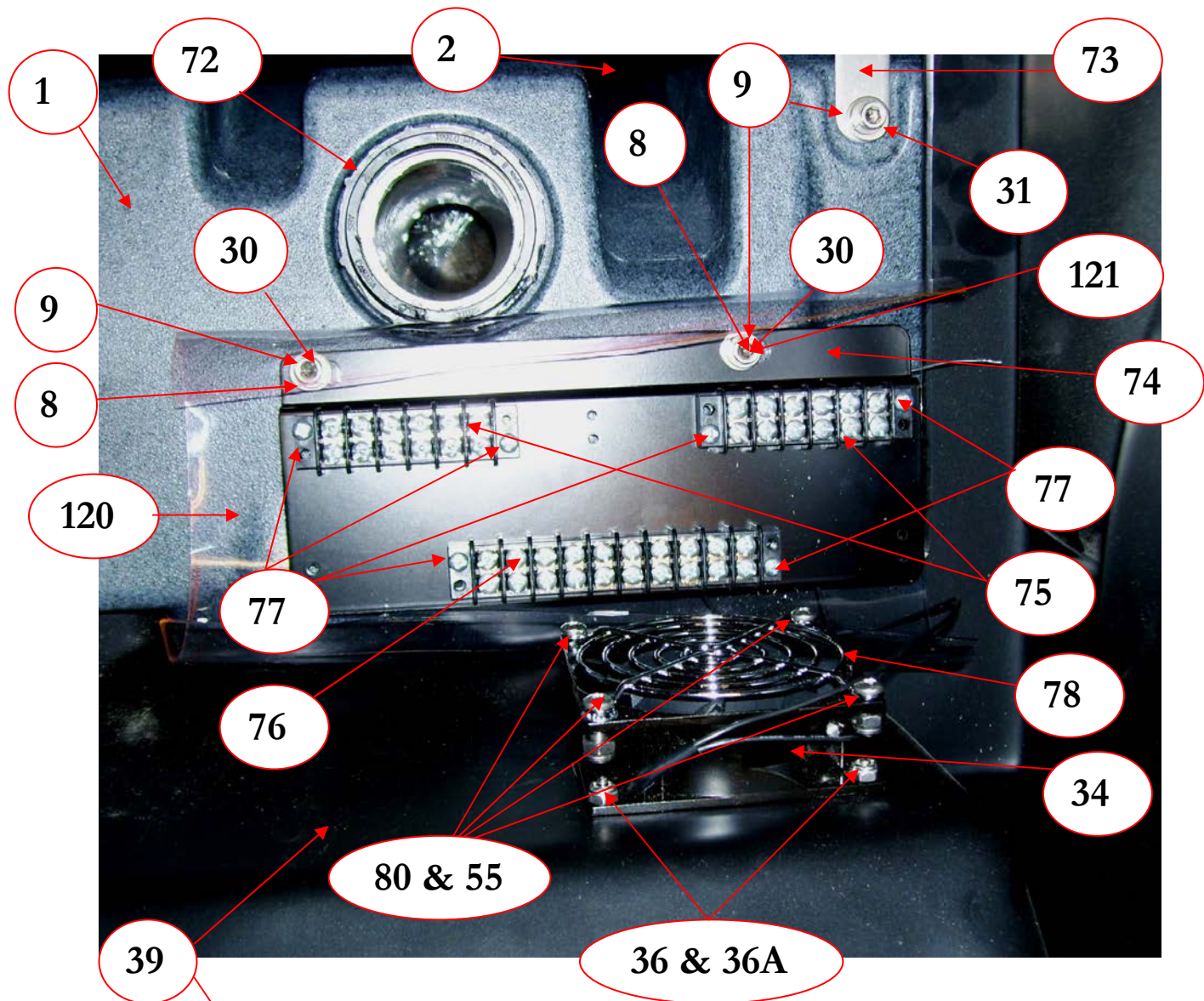

BOTTOM VIEW SOLUTION TANK & BASE SKIRT

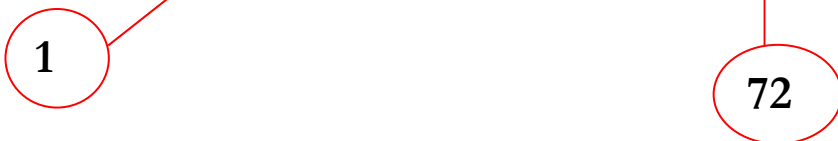
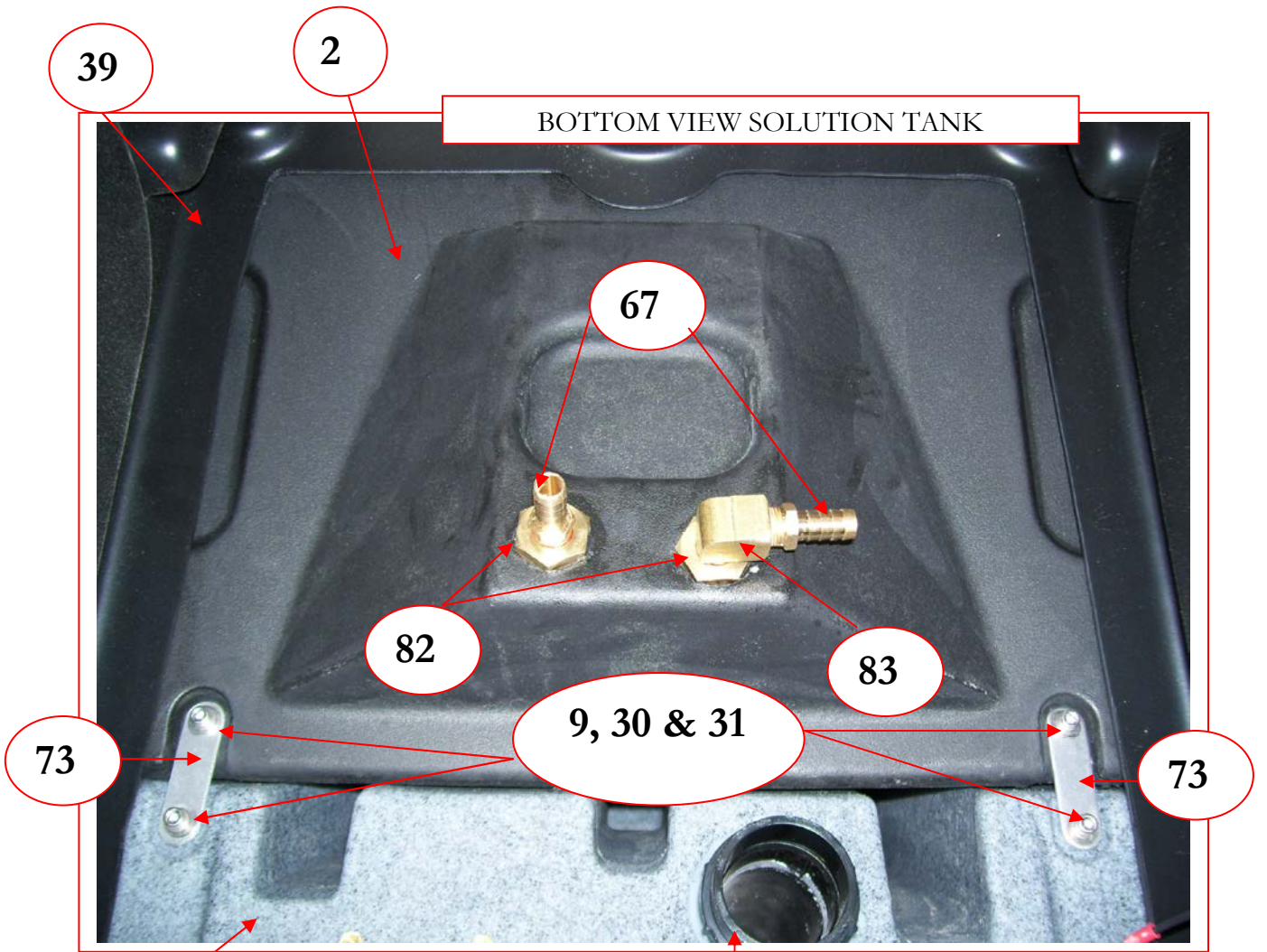

INSIDE SOLUTION TANK

INSIDE RECOVERY TANK
VACUUM SHUTOFF AND PUMP-OUT FILTER
REMOVED

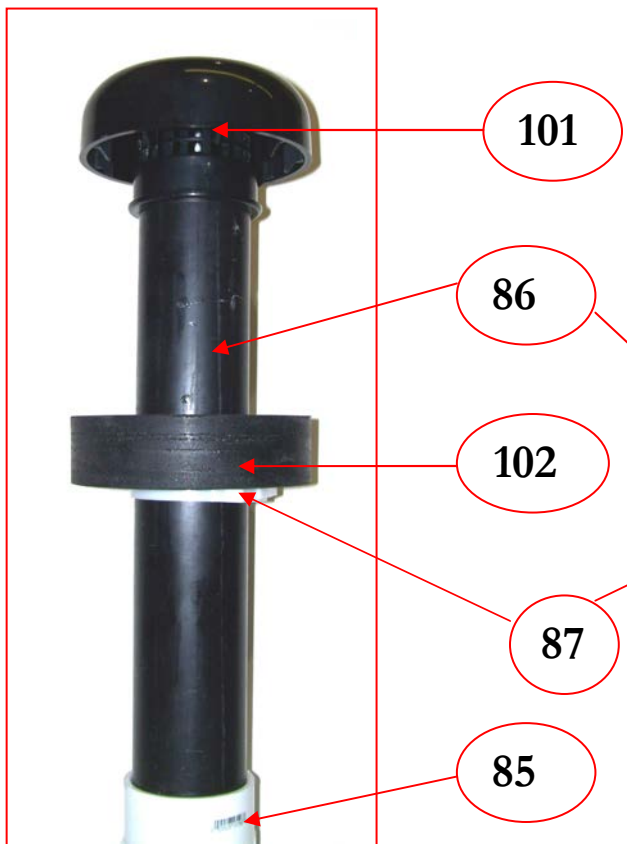
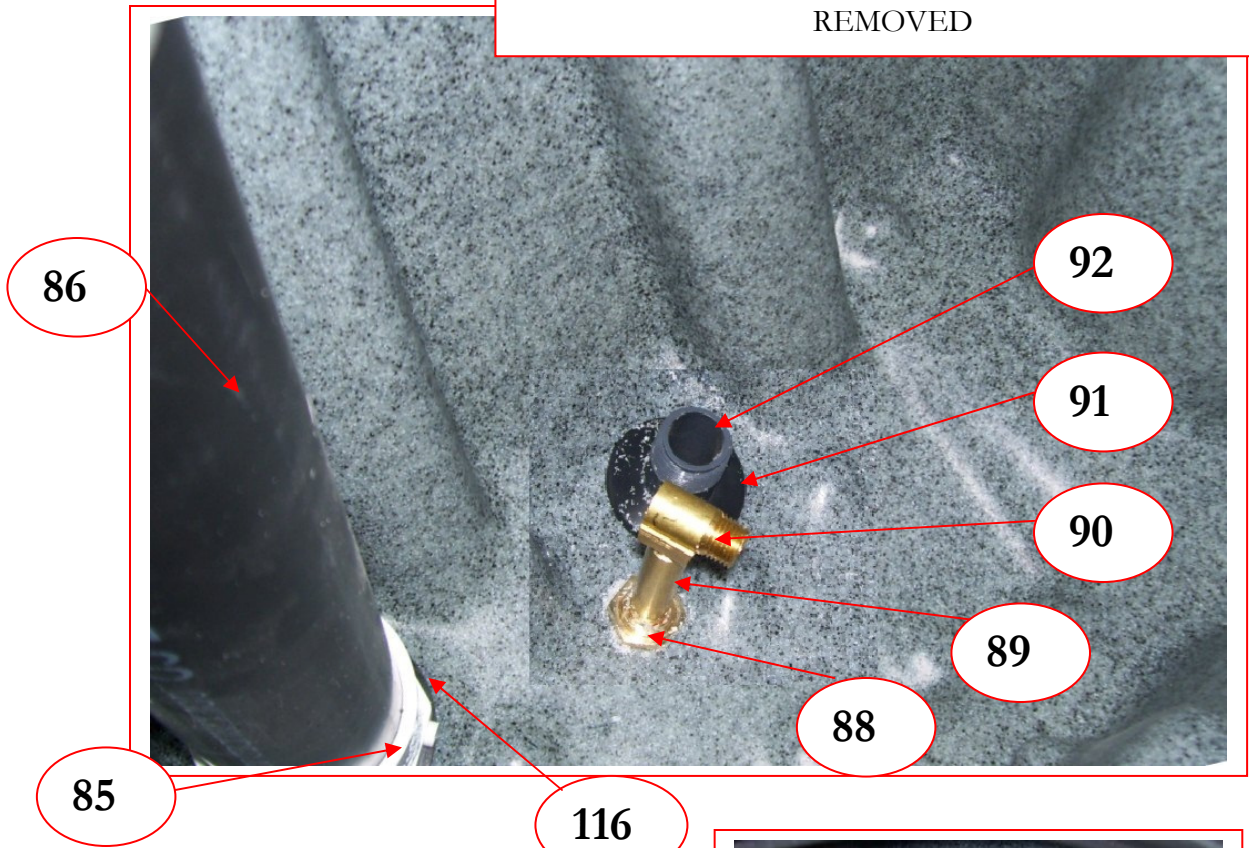

VACUUM SHUTOFF ASSEMBLY

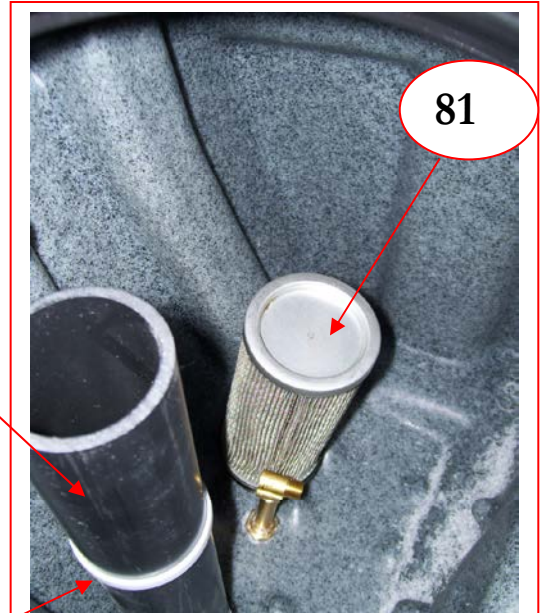

INSIDE RECOVERY TANK
WITH PUMP-OUT FILTER IN
PLACE

PUMP-OUT CONNECTIONS

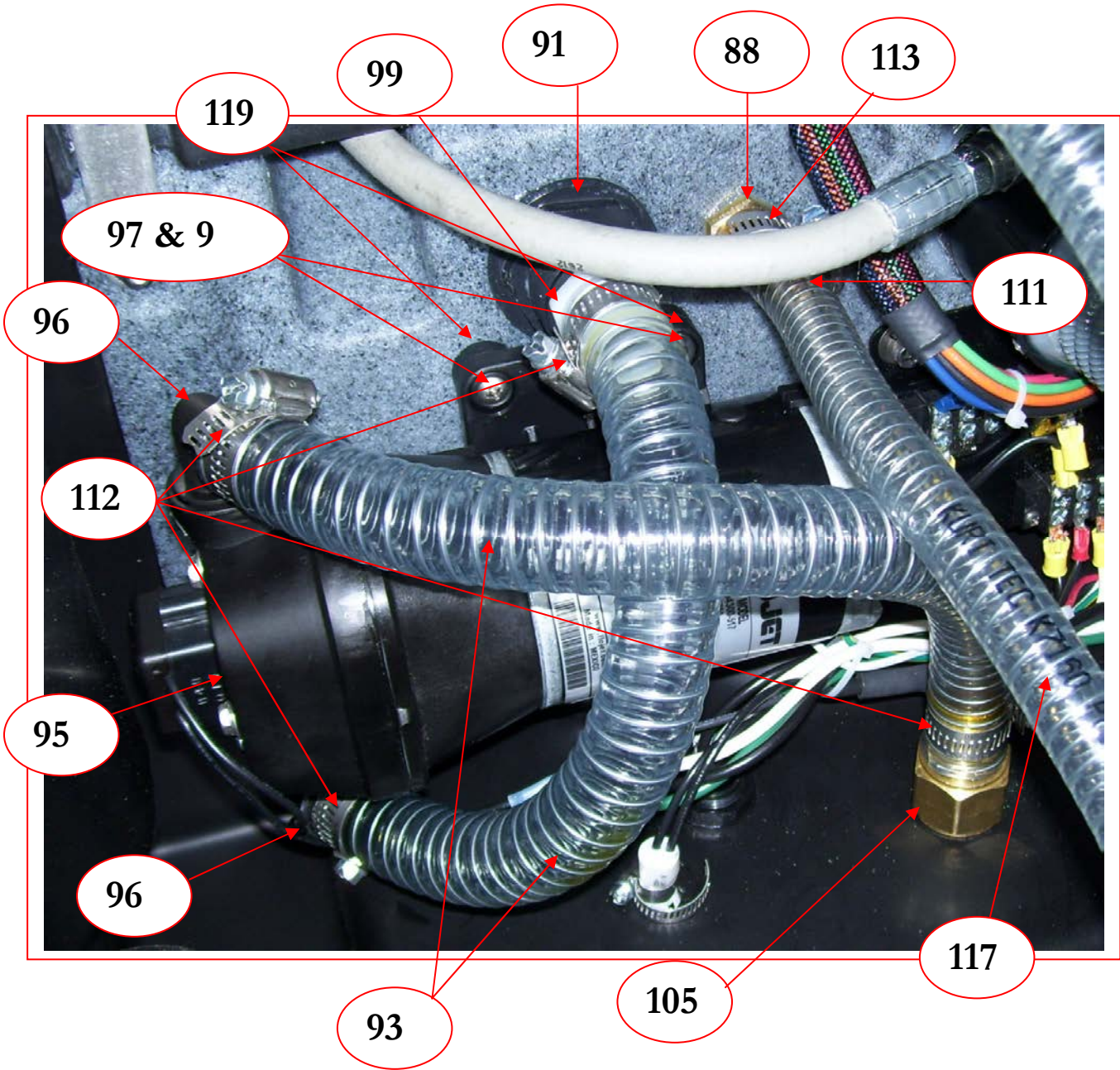

PUMP-OUT PARTS

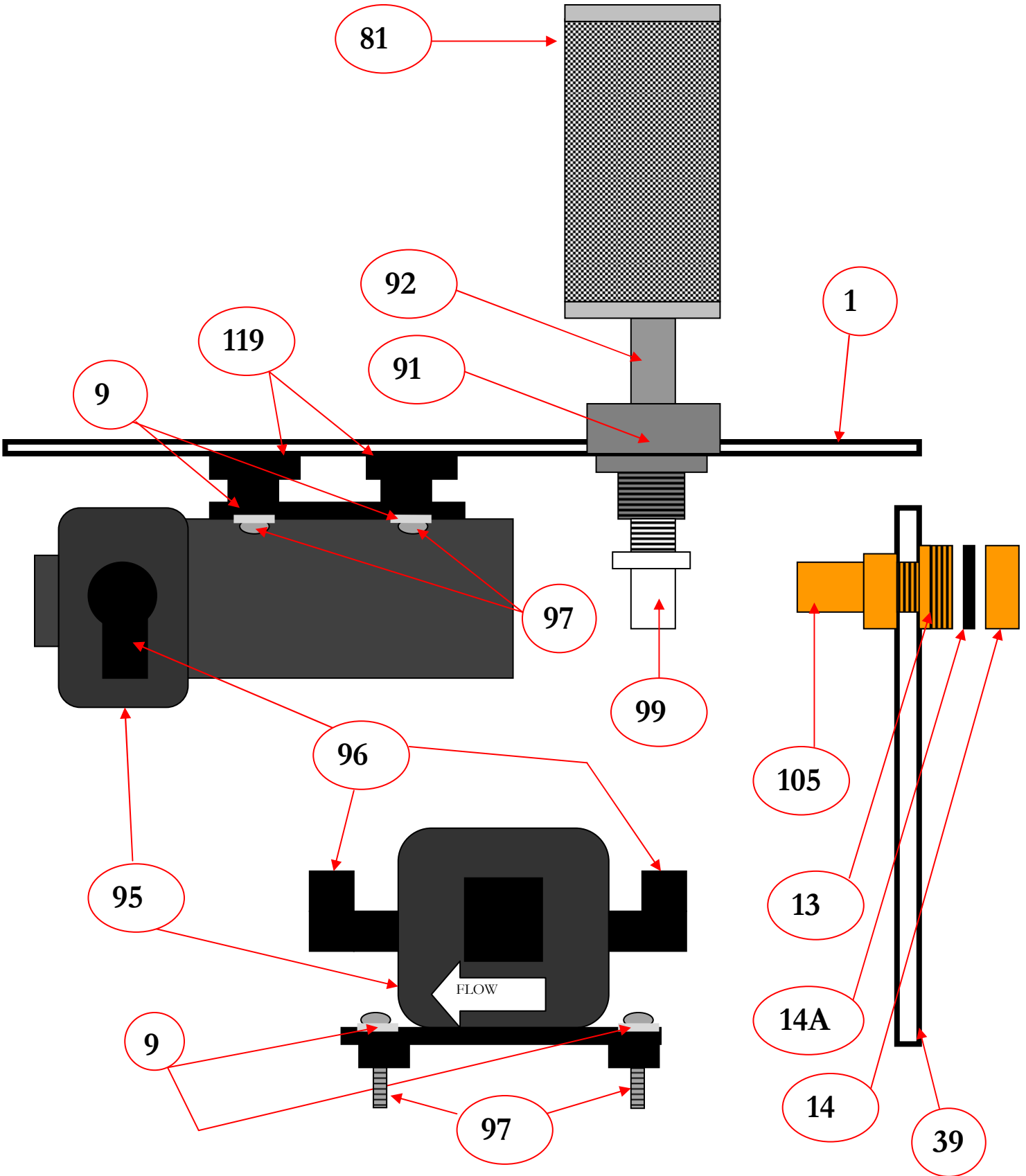

KEY	PART #	DESCRIPTION	KEY	PART #	DESCRIPTION
1	NM5704	RECOVERY TANK	21	AH101B	QUICK CONNECT FEMALE 1/4"
2	NM5702	SOLUTION TANK	22	BR174	ADAPTER 1/4" M-F
3	PFA11	WASHER 5/16" FLAT SS	23	NM5751	WASHER 1/2" FLAT SS
4	NM5724	WHEEL 2-1/2" GRAY	23A	NM5751A	WASHER 1/2" FLAT SS WITH NEOPRENE BACKING
5	NM5143	ACORN NUT CAP 5/16-18	24	NM5743	CONTROL PANEL PLATE
NS	NM5137	SCREW 5/16-18 X 2.75" HX SS	25	NM5743B	MX3-1200 PANEL DECAL
6	1650-5695	LID ASSY WASTE TANK	26	NM5009	CORD 12GA W/ PLUG (QTY 2)
7	PA187	SCREW #10 X 5/8" PH SS(QTY 6)	27	NM5038	CORD STRAIN RELIEF (QTY 2)
NS	NM5718A	GASKET WASTE TANK DECK	27A	NM5039	NUT CORD STRAIN RELIEF
8	NM5028	SCREW 1/4-20 X 1/2" SOCHD SS	28	PEA11	GATE VALVE 1-1/2" MPT
9	NM5066	WASHER 1/4" FLAT SS	29	NM5759	CORD WRAP BRACKET (QTY 2)
10	NM5840	WAND HOLDER STRAP LONG TOP STRAP	30	NM5014	WASHER 1/4" LOCK SS
11	NM5844	WAND HOLDER BUCKLE	31	NM4063	SCREW 1/4-20 X 3/4" SOCHD SS
12	NM5842	WAND HOLDER STRAP SHORT BOTTOM STRAP	32	NM5722	WHEEL 12" with HUB CAP
13	BR319	ADAPTER 3/4" MPT X 3/4" MGH	NS	NM5010	AXLE CAP – PUSH NUT
14	BR325	GARDEN HOSE CAP	33	NM4447	GREEN NEON LIGHT 120V
14A	BR600	GARDEN HOSE WASHER	34	NM5754	COOLING FAN
15	AH68	BARB 2" X 2" MPT PVC	35	NM5757	PLASTIC FAN COVER
NS	AH224	FLASH CUFF 2" MALE - MPT	36	NM5753	SCREW 6-32 X 3/4" PPH SS(QTY 4)
NS	AH201	FLASH CUFF 2" FEMALE 1.5"	37	NM5710A	BASE PLATE ASSEMBLY Comes with Lift Handle & Hinges
16	NM5714	ROCKER SWITCH DPST (QTY 4)	38	NA041	HANDLE
17	PT063	PRESSURE GAUGE 2000PSI	39	NM5700	BASE SKIRT
18	PT017	UNLOADER 2000PSI	40	NM5750	HINGE (QTY 3)
19	NM5747	SCREW 8-32 X 1" SOHD SS(QTY 4)	41	NM5017	SCREW 1/4-20 X 3/4" HXHD SS
19A	NM5793	NUT 8-32 NYLOCK SS (QTY 4)	41A	NM4261	NUT 1/4-20 NYLOCK
20	PHY018-005	CIRCUIT BREAKER 20AMP	42	NM5947	SCREW 10-24 x 1/2" PPH SS(QTY 4)

KEY	PART #	DESCRIPTION	KEY	PART #	DESCRIPTION
42A	PHY094-034	NUT 10-24 NYLOCK SS(QTY 4)	67	BR030	BARB 1/2" X 3/8" MPT
43	NM5748	AXLE REAR WHEELS – 22.5"	68	NM5086	HOSE 1/2" ID CLEAR COIL
44	AP48	1200PSI PUMP WITH MOTOR	69		ELBOW 90 BARB 1/2" X 3/8" MPT
45	NM5096	PRIMING VALVE	70		ELBOW 90 BARB 3/8" X 1/4" MPT
46	AV14	VACUUM MOTOR 3-STAGE	71	BR284	ELBOW 90DEG 3/8" STREET
47	NM5706	VACUUM MANIFOLD	72	NM5712	ADAPTER 2" FPT X SPG
47A	PA010A	VACUUM GASKET	73	NM5027	BRACKET SOL/REC TANK
48	NM5728	GATE VALVE 2" W/ KEEPER	74	NM5738	BRACKET TERMINAL BLOCKS
49	NM5728A	GASKET VACUUM VALVE	75	NM5730	TERMINAL BLOCK 6 SPACE
50	NM5141	SCREW 1/4-20X3.25" SOCHD SS (QTY 6)	76	NM5732	TERMINAL BLOCK 10 SPACE
51	NM5726	VACUUM HOSE 2" – PER INCH	77	NM5142	SCREW #6 X 1/2" PPH SS (QTY 6)
52	PA051	HOSE CLAMP 2-2.75"	78	NM5756	FAN GUARD – WIRE FORMED
53	NM5705	DECAL VAC CONNECTION	79	NM4031	NUT 6-32 NYLOCK SS
54	NM5133	SCREW 1/4-20 X 2 SOCHD SS	80	NM5124	SCREW 8-32 X 1/2" PPH SS
55	NM5793	NUT 8-32 NYLOCK SS	81	NM5746	FILTER SS - 1" FPT <i>*Will need to order 1687-8922 1" to 3/4" reducer</i>
56	NM5124	SCREW 8-32 X 1/2" PPH SS(QTY 6)	82	NM5098	BULKHEAD FITTING 3/8"
57	NM5752C	LATCH - SLIDE(QTY 2)	83	BR284	ELBOW 90DEG 3/8" STREET
58	NM5120	SCREW 5/16-18 X 3/4" HH SS	84	PP14-806504	ACORN STRAINER 3/4" FPT
59	PFA10	NUT 5/16-18 NYLOCK SS	85	NM5727	ADAPTER 2"MPT X H PVC
60	NM5720	CASTER 5" (QTY 2)	86	PA029	PIPE 2" ABS (13.5")
61	NM5752B	LATCH HOOK - KEEPER	87	NM5741E	CLAMP NYLON 2-2.5"
62	NM5752A	SPACER – LATCH HOOK	88	NM5087	BULKHEAD FITTING 1/4"
63	NM5128	SCREW 8-32 X 3/4" PPH SS(QTY 4)	89	BR083	NIPPLE 1/4" X 3" BRASS
64	NM4261	NUT 1/4-20 NYLOCK SS	90	BR282	ELBOW 90DEG 1/4" STREET
65	BR132	NIPPLE 3/8" X 1/4"	91	NM5742	BULKHEAD FITTING 3/4" PVC
66	BR254	STREET TEE 3/8"	92	NM5744	NIPPLE 3/4" X 2" PVC

KEY	PART #	DESCRIPTION	KEY	PART #	DESCRIPTION
93	NM5093	HOSE 3/4" ID CLEAR COIL	119	NM4116	GROMMET 3/8"
94	PH07	HOSE CLAMP FOR 1/2" HOSE	120	NM5737	MOISTURE BARRIER
95	AP37	PUMP-OUT PUMP	121	NM5433	1/4" INTERNAL STAR WASHER SS
96	PF20381-010	ELBOW 90 3/4" BARB QUAD FTTG	122	NM5705C	DECAL CSA WARNING
97	NM5850	SCREW 10-24 X 1.25" PPH SS	NS	NM5025	RIVET – VAC HOSE END
98	NM4255	WASHER #10 FLAT SS	NS	NM5713	ADAPTER 2"FPT X HSLIP ABS
99	BR048P	BARB 3/4" X 3/4" MPT NYLON	NS	NM5709	SPACER UNLOADER MOUNT
100	AH102B	QUICK CONNECT MALE 1/4"	NS	NM5736	ISOLATOR – PUMP MOUNT
101	NM5735	FILTER CAP ASSEMBLY	NS	NM5794	SCREW 5/16-18 X 1" HXHD SS
102	NM5741F	FLOAT VACUUM SHUTOFF	NS	NM5792	WASHER 5/16" FLAT FENDER
103	NM5705B	DECAL DUAL CIRCUIT LIGHT	NS	NM5703	WIRING HARNESS - UPPER
104	BR282A	ELBOW 90DEG 1/4" LONG STREET	NS	NM5701	WIRING HARNESS - LOWER
105	BR049	BARB 3/4" X 3/4" FPT	NS	NM5758	KIT DUAL CIRCUIT WIRING
106	PHY106-028	RUBBER VACUUM PLUG	NS	NM5711	DECAL NAUTILUS SIDE (QTY 2)
107	NM4263	SCREW TEK #10 X 5/8" SS	NS	NM4087	SCREW 1/4-20 X .63" SOC BH SS
108	NM4460	CABLE	NS	NM5434	#6 INTERNAL STAR WASHER SS CONTROL PANEL GROUND LUG
109	NM4462	SLEEVE #7 CABLE CLAMP	NS		SERIAL NUMBER PLATE WITH FOUR RIVETS
110		TEE 3/8" BRANCH F-M-F	NS	NM5933	3/16" INT STAR WASHER SS FAN GROUND WIRE CONNECT
111	BR028	BARB 1/2" X 1/4" MPT	NS	1687-8922	1" to 3/4" Reducer
112	PH09	HOSE CLAMP FOR 3/4" HOSE			
113	NA2250	HOSE CLAMP FOE 3/8" HOSE			
114	NM5705A	DECAL POWER PRIME VALVE			
115	NM5125	WASHER 1/2" FLAT ZINC PL			
116	NM5725	GASKET VACUUM RISER PIPE			
117	NM5082	HOSE 3/8" CLEAR COIL			
118	NM4472	HOSE CLAMP W/ THUMB SCREW			

DESCRIPTION	HOSE TYPE	LENGTH	NOTES
VAC HOSE REC TANK TO MANIFOLD	2" VAC – NM5726 SOLD PER FT	29"	TANK END: 1 - NM5713 2 – NM5025 VAC END: HOSE CLAMP PA051
VAC HOSE VAC 1 TO MANIFOLD	2" VAC – NM5726 SOLD PER FT	9.5"	VAC END: HOSE CLAMP PA051 MANIFOLD END HOSE CLAMP NM4472
VAC HOSE VAC 2 TO BASE	2" VAC – NM5726 SOLD PER FT	9.5"	BOTH ENDS: HOSE CLAMP PA051
SOLUTION HOSE SOL TANK TO PUMP TEE FITTING	1/2" ID CLEAR COIL NM5086 SOLD PER INCH	18"	BOTH ENDS: HOSE CLAMP PH07
SOLUTION HOSE PUMP TO PUMP TEE FITTING	1/2" ID CLEAR COIL NM5086 SOLD PER INCH	12" (QTY 2)	BOTH ENDS: HOSE CLAMP PH07
SOLUTION HOSE UNLOADER TO SOL TANK	1/2" ID CLEAR COIL NM5086 SOLD PER INCH	32"	BOTH ENDS: HOSE CLAMP PH07
SOLUTION HOSE PRIME VALVE TO REC TANK	3/8" ID CLEAR COIL NM5082 SOLD PER INCH	27"	BOTH ENDS: HOSE CLAMP NA2250
HP HOSE #1 PUMP TO UNLOADER	HP PULSE SOLD ASSEMBLED	50" ITEM# 30805	BOTH ENDS: 3/8" MS
HP HOSE #2 PUMP TO GAUGE	HP PULSE SOLD ASSEMBLED	45" ITEM# PH509	GAUGE END: 1/4" MS PUMP END: 3/8" MS
HP HOSE #3 UNLOADER TO HP HOSE #4	HP PULSE SOLD ASSEMBLED	17" ITEM# PH505	UNLOADER END: 3/8" MS JOINT END: 1/4" MS
HP HOSE #4 OUTLET QC TO HP HOSE #3	1/4" HP HYDROCOIL AH79CF SOLD PER FT	19.5"	QC END: XAF1 (M) * JOINT END: XAF2 (FM)
DRAIN HOSE REC TANK TO PUMP-OUT PUMP	3/4" CLEAR COIL NM5093 SOLD PER INCH	14"	BOTH ENDS: HOSE CLAMP PH09
DRAIN HOSE PUMP-OUT PUMP TO PUMP-OUT OUTLET FITTING	3/4" CLEAR COIL NM5093 SOLD PER INCH	13"	BOTH ENDS: HOSE CLAMP PH09

* FITTINGS ADDED BETWEEN HOSE #4 AND CONTROL PANEL:
(1) NM5751, (2) BR174 & (1) BR282

Limited Warranty

Section

4

Your Nautilus MX3-1200 is designed to give you years of reliable service. If a problem should arise use the troubleshooting section in the operation manual to diagnose and correct the problem if possible.

If you are unable to determine the cause or solution to the problem contact your distributor or Hydro-Force for assistance.

Hydro-Force warrants the roto-molded tanks and base of the Nautilus MX3-1200 to be free from defects in material or workmanship for five years from the date of purchase.

All other components of the Nautilus MX3-1200 are warranted to be free of defects in material and workmanship for one year from the date of purchase.

During the warranty period, Hydro-Force will, at its option, repair or replace components which prove to be defective. This warranty does not provide for replacement of complete units due to defective components. Any costs for transportation or related service labor are not covered in this warranty. Replacement parts are warranted only for the remainder of the original warranty period.

This warranty shall not apply to defects resulting from improper operation, lack of maintenance, unauthorized modification, chemical incompatibility, misuse, abuse or exposure to freezing temperature conditions. It does not cover normal wear items such as o-rings, valve seals, pump seals, hoses, jets, cords, batteries, or other items which require replacement as a result of ordinary usage.

To obtain warranty service for the Nautilus MX3-1200, contact your distributor or Hydro-Force. If the extractor must be returned to Hydro-Force or an authorized service center, the purchaser shall prepay shipping charges for products returned for warranty service. No returned items will be accepted by Hydro-Force without prior authorization. All returns must have a return authorization number, issued by Hydro-Force, clearly marked on the exterior of the package.

Hydro-Force makes no other warranty either expressed or implied with respect to this product.

The remedies provided herein are the purchaser's sole and exclusive remedies. In no event shall Hydro-Force be liable for any direct, indirect, special, incidental or consequential damages.

This warranty gives you specific legal rights. You may also have other rights which vary from jurisdiction to jurisdiction.